

TEM[®]

2022

Ürün Broşürü

İÇİNDEKİLER

2-10

- Alüminyum Grup Prizler

11-15

- Masa Tipi Grup Prizler

16-20

- Aydınlatma Grubu

21-22

- Priz Kutuları

23-25

- Modüler Prizler



26

- IEC Soketler

27

- GST Soketler

28

- Gerilim Koruma (SPD)

29-30

- Wireless Şarj

31-32

- Multimedya Soketler

33-34

- Faceplate - Konnektörler - Kapaklar

35

- Akım Koruma Cihazları - Anahtarlar

36

- Bluetooth Hoparlör



TEM 1U PDU

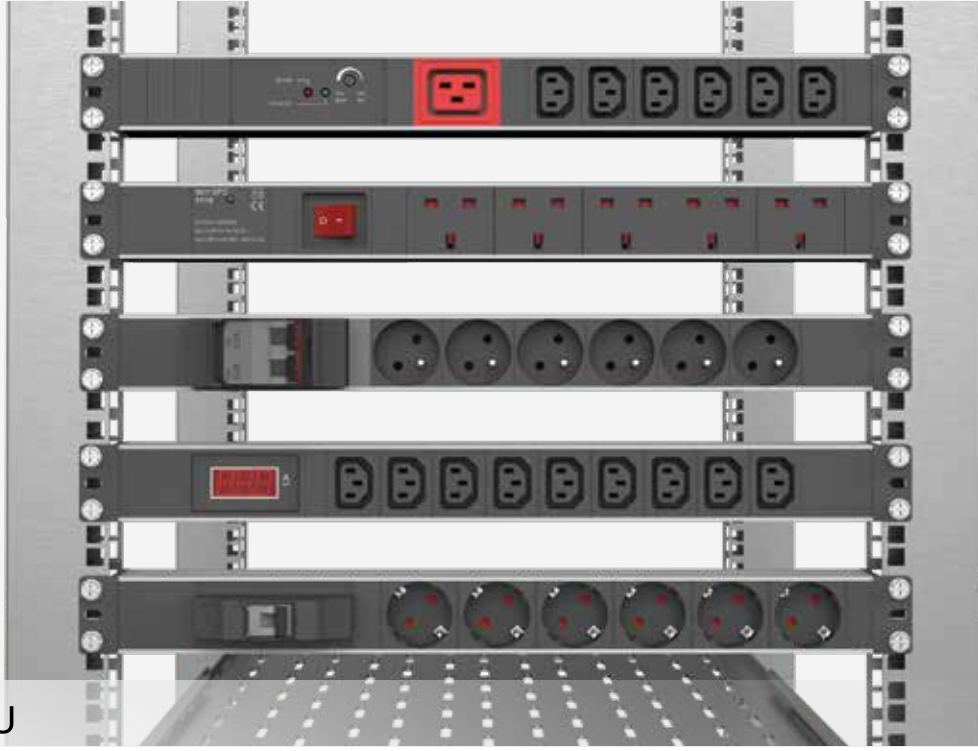

Standart



Ürün Kodu

- 1400.1070.000
- 19 1400.1080.000
- 1400.1090.000
- 1400.2070.000
- 19 1400.2080.000
- 1400.2090.000

Açıklama

- 7 Şebeke
- 8 Şebeke
- 9 Şebeke
- 7 UPS
- 8 UPS
- 9 UPS

Gerilim Korumalı



Ürün Kodu

- 1404.1060.000
- 19 1404.1070.000
- 1404.1080.000
- 1404.2060.000
- 19 1404.2070.000
- 1404.2080.000

Açıklama

- 6 Şebeke + Gerilim Koruma
- 7 Şebeke + Gerilim Koruma
- 8 Şebeke + Gerilim Koruma
- 6 UPS + Gerilim Koruma
- 7 UPS + Gerilim Koruma
- 8 UPS + Gerilim Koruma

Anahtarlı



Ürün Kodu

- 1403.1060.000
- 19 1403.1070.000
- 1403.1080.000
- 1403.2060.000
- 19 1403.2070.000
- 1403.2080.000

Açıklama

- 6 Şebeke + Anahtar
- 7 Şebeke + Anahtar
- 8 Şebeke + Anahtar
- 6 UPS + Anahtar
- 7 UPS + Anahtar
- 8 UPS + Anahtar

Tek Sigortalı



Ürün Kodu

- 1401.1040.000
- 19 1401.1060.000
- 1401.1080.000
- 1401.2040.000
- 19 1401.2060.000
- 1401.2080.000

Açıklama

- 4 Şebeke + Tekli Sigorta
- 6 Şebeke + Tekli Sigorta
- 8 Şebeke + Tekli Sigorta
- 4 UPS + Tekli Sigorta
- 6 UPS + Tekli Sigorta
- 8 UPS + Tekli Sigorta

Çift Sigortalı



Ürün Kodu

- 1411.1040.000
- 19 1411.1060.000
- 1411.1080.000
- 1411.2040.000
- 19 1411.2060.000
- 1411.2080.000

Açıklama

- 4 Şebeke + Çift Sigortalı
- 6 Şebeke + Çift Sigortalı
- 8 Şebeke + Çift Sigortalı
- 4 UPS + Çift Sigortalı
- 6 UPS + Çift Sigortalı
- 8 UPS + Çift Sigortalı

Butonlu Akım Korumalı



Ürün Kodu

- 1412.1060.000
- 19 1412.1070.000
- 1412.1080.000
- 1412.2060.000
- 19 1412.2070.000
- 1412.2080.000

Açıklama

- 6 Şebeke + Akım Koruma
- 7 Şebeke + Akım Koruma
- 8 Şebeke + Akım Koruma
- 6 UPS + Akım Koruma
- 7 UPS + Akım Koruma
- 8 UPS + Akım Koruma

Anahtarlı Akım Korumalı



Ürün Kodu

- 1413.1060.000
- 19 1413.1070.000
- 1413.1080.000
- 1413.2060.000
- 19 1413.2070.000
- 1413.2080.000

Açıklama

- 6 Şebeke + Anahtarlı Akım Koruma
- 7 Şebeke + Anahtarlı Akım Koruma
- 8 Şebeke + Anahtarlı Akım Koruma
- 6 UPS + Anahtarlı Akım Koruma
- 7 UPS + Anahtarlı Akım Koruma
- 8 UPS + Anahtarlı Akım Koruma

1U Kapak Modelleri

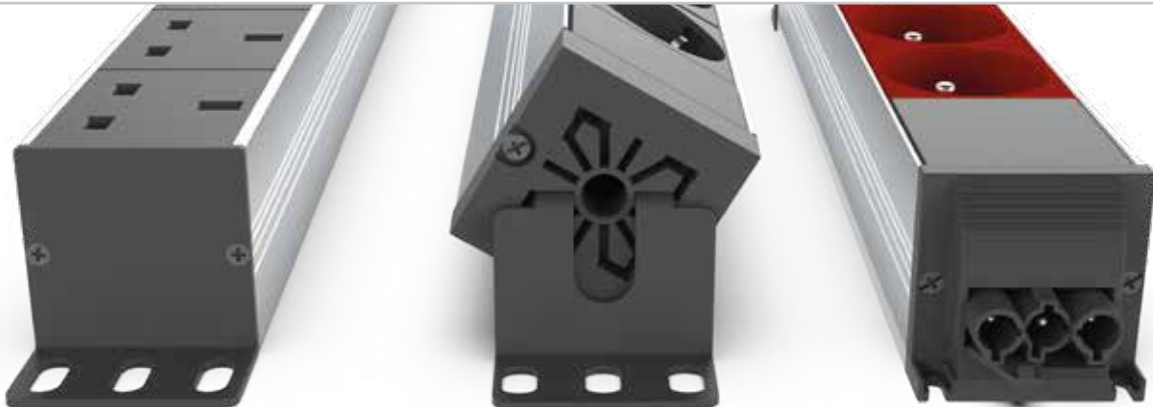

TEM 1U GST PDU



1411.0000.003
Çift Sigorta Modülü



1414.0000.003
SPD + EMI-RFI Filtre Modülü



1415.0000.003
SPD + Anahtar Modülü



1400.1020.0202.3
2'li USB Şarj + 2 Şebeke



1400.1040.003
4 Şebeke



1403.1030.003
3 Şebeke + Anahtar



725.3150.893
GST (Dişi + Erkek)
3x1,5 H05VV-F 3m



725.3150.913
3m GST Dişi + Unischuko
3x1,5 H05VV-F 3m



725.3150.933
3m GST Dişi + C14
3x1,5 H05VV-F 3m

TEM U62 PDU



Boş Alüminyum Gövde



Ürün Kodu

Açıklama

1620.0010.000	10 x 22.5 Modül
1620.0012.000	12 x 22.5 Modül
1620.0014.000	14 x 22.5 Modül
1620.0016.000	16 x 22.5 Modül
1620.0018.000	18 x 22.5 Modül
1620.0020.000	20 x 22.5 Modül

Örnek Ürünler



1620.1232.8711.0
3 Şebeke + 2 UPS + 1 Cat6 + 1 Cat3



1620.1222.8722.0
2 Şebeke + 2 UPS + 2 Cat6 + 2 Cat3



1620.1222.872111.0
2 Şebeke + 2 UPS + 1 Cat6 + 1 Cat 3
+ 2'li USB Şarj



1620.1223.8721.0
2 Şebeke + 3 UPS + 2 Cat6 + 1 Cat3



1620.1233.8711.0
3 Şebeke + 3 UPS + 1 Cat6 + 1 Cat3



1620.1030.153111.0
3 Şebeke + 1 VGA + 1 HDMI + 1 USB Şarj



TEM U42 PDU

Standart



Ürün Kodu

- 1420.1070.000
- 19 1420.1080.000
- 1420.1090.000
- 1420.2070.000
- 19 1420.2080.000
- 1420.2090.000

Açıklama

- 7 Şebeke
- 8 Şebeke
- 9 Şebeke
- 7 UPS
- 8 UPS
- 9 UPS

Tek Sigortalı



Ürün Kodu

- 1421.1040.000
- 19 1421.1060.000
- 1421.1080.000
- 1421.2040.000
- 19 1421.2060.000
- 1421.2080.000

Açıklama

- 4 Şebeke + Tekli Sigorta
- 6 Şebeke + Tekli Sigorta
- 8 Şebeke + Tekli Sigorta
- 4 UPS + Tekli Sigorta
- 6 UPS + Tekli Sigorta
- 8 UPS + Tekli Sigorta

Anahtarlı



Ürün Kodu

- 1423.1060.000
- 19 1423.1070.000
- 1423.1080.000
- 1423.2060.000
- 19 1423.2070.000
- 1423.2080.000

Açıklama

- 6 Şebeke + Anahtar
- 7 Şebeke + Anahtar
- 8 Şebeke + Anahtar
- 6 UPS + Anahtar
- 7 UPS + Anahtar
- 8 UPS + Anahtar



1420.1223.8721.0
2 Şebeke + 3 UPS + 2 Cat6 + 1 Cat3



1420.1233.8711.0
3 Şebeke + 3 UPS + 1 Cat6 + 1 Cat3



1420.1232.8711.0
3 Şebeke + 2 UPS + 1 Cat6 + 1 Cat3



1420.1222.8722.0
2 Şebeke + 2 UPS + 2 Cat6 + 2 Cat3



1422.1050.000
5 Şebeke + Çift Sigortalı



1420.1040.110
4 Şebeke + 2'li USB Şarj



1430.1223.8721.0
2 Şebeke + 3 UPS + 2 Cat6 + 1 Cat3



1430.1222.8722.0
2 Şebeke + 2 UPS + 2 Cat6 + 2 Cat3



1430.1232.8711.0
3 Şebeke + 2 UPS + 1 Cat6 + 1 Cat3



TEM G70 Masaüstü PDU

	Ürün Kodu	Açıklama	^a (mm)
	1700.2030.8711.0	3 UPS + 1 Cat6 + 1 Cat3	280
	1700.1222.8711.0	2 Şebeke + 2 UPS + 1 Cat6 + 1 Cat3	348
	1700.2631.8711.0	3 UPS + 1 Üniversal Priz + 1 Cat6 + 1 Cat3	347,5
	1700.2030.187111.0	3 UPS + 1 Cat6 + 1 Cat3 + 1 USB Şarj	302,5

* **a** = yan kapaklar dahil toplam ürün ölçüsü

Montaj Ayağı

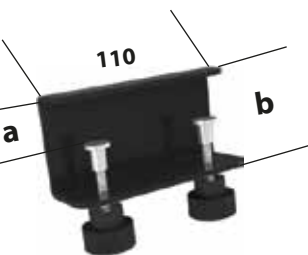

Ürün Kodu	Açıklama	^a (mm)	^b (mm)
740.050.030	Küçük Boy	$18 \leq a \leq 35$	56
740.050.070	Büyük Boy	$35 \leq a \leq 75$	96

* **a** = Masa kalınlığı ölçüsü

Kolon Kanal Modelleri

U62

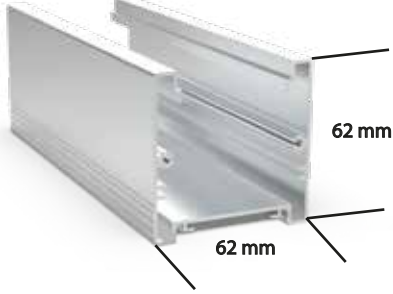

U62 Çiftli



H100

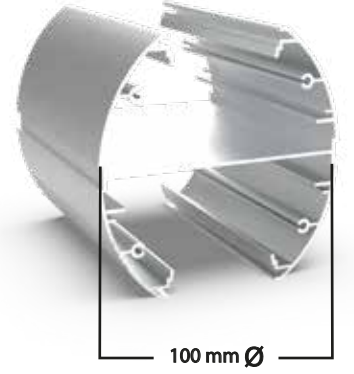

1400.1244.8722.0
4 Şebeke + 4 UPS +
2 Cat6 + 2 Cat3



1400.1040.8142.0
4 Şebeke + 2x2'li USB Şarj
+ 4 Cat6



1400.1020.135222.0
2 Şebeke + 2 USB Şarj +
2 VGA + 2 HDMI



1400.1040.120
2 Şebeke
2 USB

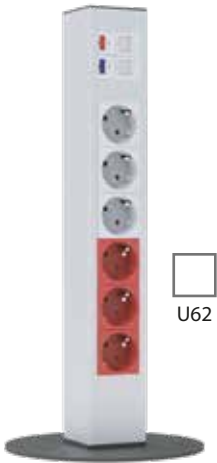

1100.1233.8711.0
3 Şebeke + 3 UPS +
1 Cat 6 + 1 Cat 3



1000.1244.136111.0
4 Şebeke + 4 UPS + 2 USB Şarj
+ 2 HDMI + 2 RCA



1100.1222.8200.0
2 Şebeke + 2 UPS
2 Cat6



1100.1040.3511.0
4 Şebeke + 1 HDMI
+ 1 VGA

TEM

Kolon Grubu

H100 Tavan Bağlantı Aparatı



H100 Kolon Ayağı



TEM 044 PDU

	Ürün Kodu	Açıklama	a (mm)
	1800.1020.210	2 Şebeke + 2'li USB Şarj	232
	1800.2020.210	2 UPS + 2'li USB Şarj	232
	1800.1030.000	3 Şebeke	205
	1800.2030.000	3 UPS	205
	1804.1020.210	2 Şebeke + 2'li USB Şarj + Akım Koruma	307
	1804.2020.210	2 UPS + 2'li USB Şarj + Akım Koruma	307
	1804.1030.000	3 Şebeke + Akım Koruma	280
	1804.2030.000	3 UPS + Akım Koruma	280

Masa kesim ölçüsü Ø60mm
Kullanılmadıkça yer kaplamayan grup priz
Özel kilit mekanizması



TEM Güç Çerçevesi

Boş Alüminyum Gövde

Ürün Kodu

Açıklama

Kesim Ölçüsü

a+7(mm)

a
(mm)

1720.0010.000

10 x 22,5 Modül

232 x 55

225

1720.0012.000

12 x 22,5 Modül

277 x 55

270

1720.0014.000

14 x 22,5 Modül

322 x 55

315

1720.0016.000

16 x 22,5 Modül

367 x 55

360

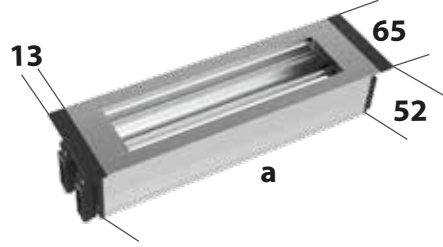

* a = yan kapaklar hariç net alüminyum ölçüsü

a+26 = Toplam ürün ölçüsü

Ürün Kodu

Açıklama

Kesim Ölçüsü

a+6(mm)

a
(mm)

1720.1020.110

2 Şebeke + USB Şarj

208,5 x 55

202,5

1720.2030.8711.0

3 UPS + 1 Cat6 + 1 Cat3

276 x 55

270

1720.4020.1511.0

2 İngiliz Prizi + 1 USB Şarj
+ VGA

243 x 55

225

1720.1222.0802.0

2 Şebeke + 2 UPS +
2 Cat6

343,5 x 55

337,5





TEM Masa Kapağı

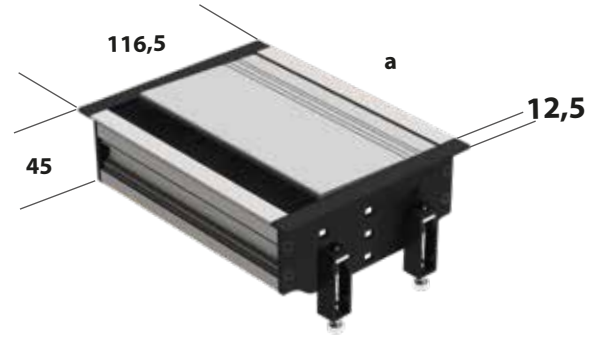
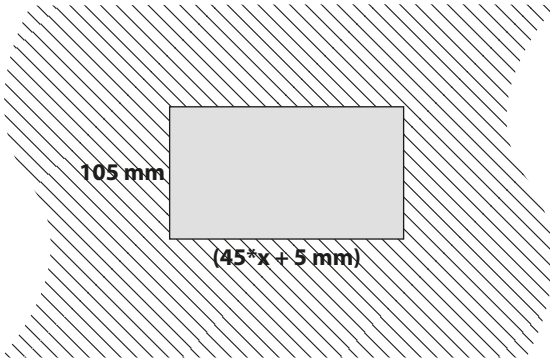

Boş Alüminyum Gövde

Ürün Kodu

Açıklama

Kesim Ölçüsü

a+7(mm)

a
(mm)

1710.0010.000

10 x 22,5 Modül

232 x 105

225

1710.0012.000

12 x 22,5 Modül

277 x 105

270

1710.0014.000

14 x 22,5 Modül

322 x 105

315

1710.0016.000

16 x 22,5 Modül

367 x 105

360



* a = yan kapaklar hariç net alüminyum ölçüsü
a+25 = Toplam ürün ölçüsü

TEM Kapaklı Güç Çerçevesi



Boş Alüminyum Gövde

Ürün Kodu

Açıklama

Kesim Ölçüsü a+35(mm)

(mm)

1730.0010.0

10 x 22,5 Modül

260 x 105

225

1730.0012.0

12 x 22,5 Modül

305 x 105

270

1730.0014.0

14 x 22,5 Modül

350 x 105

315

1730.0016.0

16 x 22,5 Modül

395 x 105

360

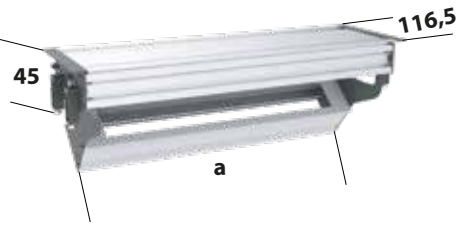

* a = yan kapaklar hariç net alüminyum ölçüsü
a+56 = Toplam ürün ölçüsü

Örnek Ürünler

Ürün Kodu

Açıklama

Kesim Ölçüsü a+35(mm)

(mm)

1730.1020.110

2 Şebeke + 1 USB Şarj

260 x 105

225

1730.1020.8711.0

2 Şebeke + 1 Cat6 + 1 Cat3

237,5 x 105

202,5

1730.1222.8711.0

2 Şebeke + 2 UPS + 1 Cat6
+ 1 Cat3

372,5 x 105

337,5

1730.1631.210

3 Şebeke + 1 Üniversal Priz
+2'li USB Şarj

395 x 105

360





TEM Yatay Masa Grubu

Boş Alüminyum Gövde	Ürün Kodu	Açıklama	Kesim Ölçüsü	^a (mm)
			a+70(mm)	
	1740.0010.0	10 x 22,5 Modül	295 x 135	225
	1740.0012.0	12 x 22,5 Modül	340 x 135	270
	1740.0014.0	14 x 22,5 Modül	385 x 135	315
	1740.0016.0	16 x 22,5 Modül	430 x 135	360

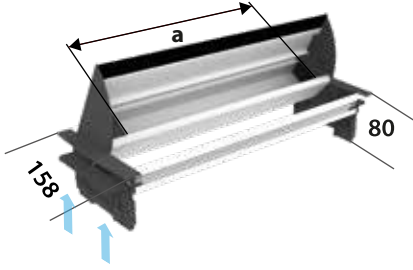

* **a** = Boş kanal içi kullanılabilirlik ölçüsü
a+70 = Ürün kesim ölçüsü
a+100 = Toplam ürün ölçüsü

Örnek Ürünler	Ürün Kodu	Açıklama	Kesim Ölçüsü	^a (mm)
			a+35(mm)	



1740.1040.820 4 Şebeke + 2 Cat6 362,5x135 292,5



1740.1222.8711.0 2 Şebeke + 2 UPS + 1 Cat6 +1 Cat3 385x135 315



1740.1224.842 2 Şebeke + 4 UPS + 4 Cat6 + Soket Girişli 520x135 450



1740.1233.840 3 Şebeke + 3 UPS + 4 Cat6 520x135 450



Kontrol Seçenekleri

- PIR Hareket Sensörü
- IR Yaklaşım Kapı Sensörü
- IR Yaklaşım Aç Kapa
- Dokunmatik Aç Kapa
- Dokunmatik 3 Kademeli Dimmer
- On / Off Anahtar

TEM Aydınlatma

- Işık Rengi: 6500 K / 3000 K
- Giriş: 220 V Sürücülü 100/200 V AC
220 V Sürücüsüz 220 V AC
24 V Sürücüsüz 24 V AC
- Montaj: Askılı
Vidalı
Mıknatıslı

Standart



	Ürün Kodu	Açıklama
220 V Sürücüsüz	1405.1.0030.X1	35cm 14W 1m Kablolu
	1405.1.0050.X1	55cm 18W 1m Kablolu
220 V Sürücülü	1405.2.0030.X1	35cm 8,4W 1m Kablolu
	1405.2.0050.X1	55cm 14W 1m Kablolu
24 V Sürücüsüz	1405.4.0030.X1	35cm 8,4W 1m Kablolu
	1405.4.0050.X1	55cm 14W 1m Kablolu

X = 0 Mıknatıssız

X = 1 Mıknatıslı

On - Off Anahtarlı



220 V
Sürücüsüz

Ürün Kodu

1405.1.0130.X1

1405.1.0150.X1

Açıklama

35cm 14W 1m Kablolu

55cm 18W 1m Kablolu

220 V
Sürücülü

1405.2.0130.X1

1405.2.0150.X1

35cm 8,4W 1m Kablolu

55cm 14W 1m Kablolu

24 V
Sürücüsüz

1405.4.0130.X1

1405.4.0150.X1

35cm 8,4W 1m Kablolu

55cm 14W 1m Kablolu

X = 0 Mıknatıssız

X = 1 Mıknatıslı

Dokunmatik Aç - Kapa



220 V
Sürücüsüz

Ürün Kodu

1405.1.0230.X1

Açıklama

35cm 14W 1m Kablolu

220 V
Sürücülü

1405.2.0230.X1

1405.2.0250.X1

35cm 8,4W 1m Kablolu

55cm 14W 1m Kablolu

24 V
Sürücüsüz

1405.4.0230.X1

1405.4.0250.X1

35cm 8,4W 1m Kablolu

55cm 14W 1m Kablolu

X = 0 Mıknatıssız

X = 1 Mıknatıslı

PIR Hareket Sensörü



220 V
Sürücüsüz

Ürün Kodu

1405.1.0330.X1

1405.1.0350.X1

Açıklama

35cm 14W 1m Kablolu

55cm 18W 1m Kablolu

220 V
Sürücülü

1405.2.0330.X1

1405.2.0350.X1

35cm 8,4W 1m Kablolu

55cm 14W 1m Kablolu

24 V
Sürücüsüz

1405.4.0330.X1

1405.4.0350.X1

35cm 8,4W 1m Kablolu

55cm 14W 1m Kablolu

X = 0 Mıknatıssız

X = 1 Mıknatıslı

Yaklaşım Kapı Sensörü



220 V
Sürücülü

24 V
Sürücüsüz

Ürün Kodu

1405.2.0430.X1
1405.2.0450.X1
1405.4.0430.X1
1405.4.0450.X1

X = 0 Miknatıssız
X = 1 Miknatıslı

Açıklama

35cm 8,4W 1m Kablolu
55cm 14W 1m Kablolu
35cm 8,4W 1m Kablolu
55cm 14W 1m Kablolu

3 Kademeli Dimmer



220 V
Sürücülü

24 V
Sürücüsüz

Ürün Kodu

1405.2.0630.X1
1405.2.0650.X1
1405.4.0630.X1
1405.4.0650.X1

X = 0 Miknatıssız
X = 1 Miknatıslı

Açıklama

35cm 8,4W 1m Kablolu
55cm 14W 1m Kablolu
35cm 8,4W 1m Kablolu
55cm 14W 1m Kablolu

IR Yaklaşım Aç - Kapa



220 V
Sürücülü

24 V
Sürücüsüz

Ürün Kodu

1405.2.0530.X1
1405.2.0550.X1
1405.4.0530.X1
1405.4.0550.X1

X = 0 Miknatıssız
X = 1 Miknatıslı

Açıklama

35cm 8,4W 1m Kablolu
55cm 14W 1m Kablolu
35cm 8,4W 1m Kablolu
55cm 14W 1m Kablolu

U20 Aydınlatma

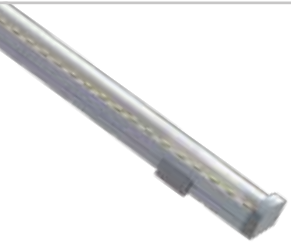

220 V

24V

Ürün Kodu

120X.243.04.36
120X.245.07.60
120X.2410.14.120
120X.223.05.40
120X.224.06.48
120X.225.10.80
120X.242.04.36

X = 0 Miknatıssız
X = 1 Miknatıslı

Açıklama

220V 1m Kablolu + 35cm 5W
220V 1m Kablolu + 41cm 6W
220V 1m Kablolu + 52cm 10W
24V 1m Kablolu + 20cm 4.3W
24V 1m Kablolu + 30cm 4.3W
24V 1m Kablolu + 50cm 7.2W
24V 1m Kablolu + 100cm 14.1W



TEM Linear Armatür

● Işık Rengi: 6500 K / 3000 K

● Giriş: 220 V Sürüclü 100/200 V AC
24 V Sürücüsüz 24 V AC

● Montaj: Askılı
Vidalı
Mıknatıslı

TİP 1U

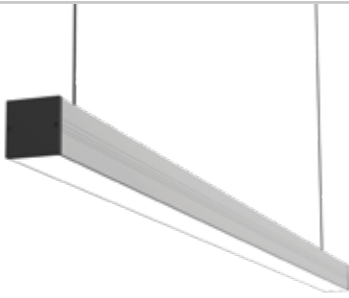

220 V
Sürüclü

Ürün Kodu

Açıklama

14025.2.0060

60cm 16,8W

14025.2.0090

90cm 25,2W

14025.2.00120

120cm 33,6W

14025.2.00150

150cm 42W

24 V

14025.4.0060

60cm 16,8W

14025.4.0090

90cm 25,2W

14025.4.00120

120cm 33,6W

14025.4.00150

150cm 42W

TİP C

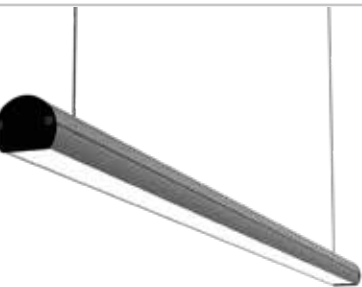

220 V
Sürüclü

Ürün Kodu

Açıklama

14425.2.0060

60cm 16,8W

14425.2.0090

90cm 25,2W

14425.2.00120

120cm 33,6W

14425.2.00150

150cm 42W

24 V

14425.4.0060

60cm 16,8W

14425.4.0090

90cm 25,2W

14425.4.00120

120cm 33,6W

14425.4.00150

150cm 42W

Yan Kapak Seçenekleri

Düz Yan Kapak
Vidalı Yan Kapak
Gst Soketli Yan Kapak

Opsiyonel Sinyal Led



Priz Seçenekleri

Şebeke
UPS
İngiliz
Fransız
IEC C13 / C19

Kontrol Seçenekleri

On / Off Anahtar
Sensör
Anahtar + Kumanda Kablosu

LED Seçenekleri

13 cm LED
30 cm LED
50 cm LED

TEM Prizli Aydınlatma

● Işık Rengi: 6500 K / 3000 K

● Giriş: 220 V Sürücülü 100/200 V AC
24 V Sürücüsüz 220 V AC

● Montaj: Askılı
Mıknatıslı

Tip 1U



220 V
Sürücüsüz

Ürün Kodu

1405.1013.1020.X0

1405.1013.2020.X0

1405.1030.1020.X0

1405.1030.2020.X0

220 V
Sürücülü

1405.2030.1020.X0

1405.2030.2020.X0

X = 0 Mıknatıssız

X = 1 Mıknatıslı

Açıklama

2 Şebeke + 13cm LED + 3m Kablo

2 UPS + 13cm LED + 3m Kablo

2 Şebeke + 30cm LED + 3m Kablo

2 UPS + 30cm LED + 3m Kablo

2 Şebeke + 30cm LED + 3m Kablo

2 UPS + 30cm LED + 3m Kablo

Tip G70



220 V
Sürücüsüz

Ürün Kodu

1705.1030.1020.X0

1705.1030.1040.X0

1705.1050.1020.X0

1705.1050.1040.X0

220 V
Sürücülü

1705.2030.1020.X0

1705.2030.1040.X0

1705.2050.1020.X0

1705.2050.1040.X0

Açıklama

2 Şebeke + 30cm LED + Kablosuz

4 Şebeke + 30cm LED + Kablosuz

2 Şebeke + 50cm LED + Kablosuz





4 Şebeke + 50cm LED + Kablosuz

2 Şebeke + 30cm LED + Kablosuz

4 Şebeke + 30cm LED + Kablosuz

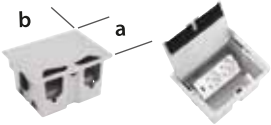
2 Şebeke + 50cm LED + Kablosuz

4 Şebeke + 50cm LED + Kablosuz

	Ürün Kodu	Açıklama	Modül	Masa Kesim Ölçüsü	
				a	b
	800.025.02X	Priz Kasası (Fırçalı-Gri, Siyah, Beyaz)	2.5x45	126	175
	800.025.022	Priz Kasası (Metalik Kaplama)			
	800.025.12X	Priz Kasası (Fırçalı-Gri, Siyah, Beyaz)	2.5x45	80	170
	800.025.122	Priz Kasası (Metalik Kaplama)			
	800.045.02X	Priz Kasası (Fırçalı-Gri, Siyah)	4.5x45	127	253
	800.045.022	Priz Kasası (Fırçalı - Metalik Kaplama)			
	800.045.12X	Priz Kasası (Fırçalı-Gri, Siyah)	4.5x45	127	253
	800.045.122	Priz Kasası (Fırçalı - Metalik Kaplama)			
	800.050.02X	Priz Kasası (Fırçalı-Gri, Siyah, Beyaz)	5x45	126	175
	800.050.022	Priz Kasası (Metalik Kaplama)			
	800.090.02X	Priz Kasası (Fırçalı-Gri, Siyah)	9x45	127	253
	800.090.022	Priz Kasası (Fırçalı - Metalik Kaplama)			

X = 1 Gri X = 3 Siyah X = 6 Beyaz

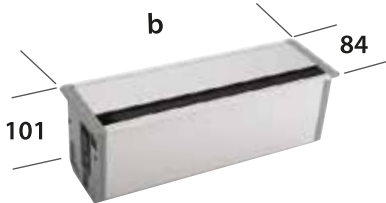

Ürün Kodu	Modül	b
810.020.01X	2x45	132
810.030.01X	3x45	171
810.040.01X	4x45	238
810.050.01X	5x45	279
810.060.01X	6x45	342
810.070.01X	7x45	387
810.080.01X	8x45	449
810.090.01X	9x45	474
810.0100.01X	10x45	534

X = 1 Elksal X = 3 Siyah X = 6 Beyaz

Tüm ölçüler mm cinsindedir.

Döşeme Altı Buat

Döşeme Altı Priz Kutusu(Boş Kutu)
Kapasite 18 Adet 22.5 Modül

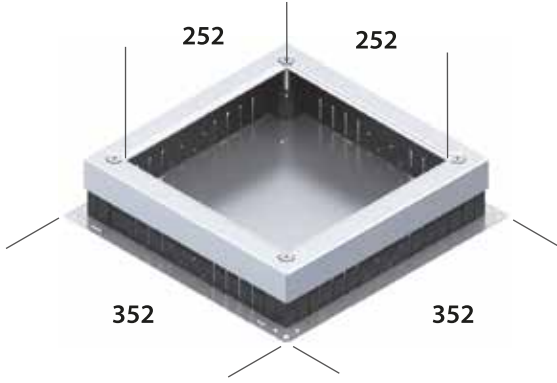

Ürün Kodu	Ölçü(mm)	Ağırlık(Kg)
205.352.000	352x352	2.563
206.252.000	252x252	1.461

113x210mm
Dahili Priz Kutuları



210.0000.0000
113x210x70mm



210.1200.4400
4 Şebeke + 4 UPS



212.1000.6000
6 Şebeke + 2'li Sigorta Yeri

210x280mm
Dahili Priz Kutuları



280.0000.0000
210x280x70mm



280.1200.6600
6 Şebeke + 6 UPS



282.1200.6300
6 Şebeke + 3 UPS + 2'li Sigorta Yeri





250.216.150
Vidalı Şebeke Prizi 45°



250.316.150
Vidalı UPS Prizi 45°



245.216.150
Tırnaklı Tek Klemensli Şebeke Prizi



245.316.150
Tırnaklı Tek Klemensli UPS Prizi



246.216.150
Tırnaklı Tek Klemensli
Şebeke Prizi 45°



246.316.150
Tırnaklı Tek Klemensli
UPS Prizi 45°



345.216.150
Tırnaklı Çift Klemensli
Şebeke Prizi



345.316.150
Tırnaklı Çift Klemensli
UPS Prizi



346.216.150
Tırnaklı Çift Klemensli
Şebeke Prizi 45°



346.316.150
Tırnaklı Çift Klemensli
UPS Prizi 45°



247.216.150
Tırnaklı Tek Klemensli
Fransız Prizi 45°



347.216.151
Tırnaklı Tek Klemensli
Fransız Prizi

Kapaklı Prizler



Çift tırnak sayesinde dikey ve yatay kullanımlara uygundur.



350.216.160
Çift Tırnaklı Çift Klemensli
Kapaklı Şebeke Prizi



350.316.160
Çift Tırnaklı Çift Klemensli
Kapaklı UPS Prizi

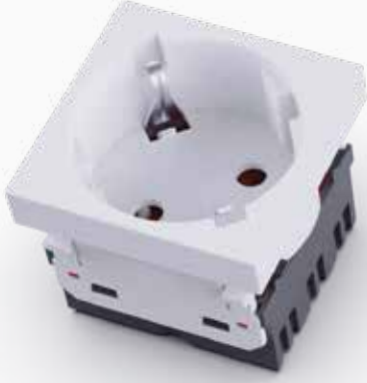

350.216.150
Çift Tırnaklı Çift Klemensli
Şebeke Prizi 45°



740.061.002
Priz Birleştirme
Aparatı



350.316.150
Çift Tırnaklı Çift Klemensli
UPS Prizi 45°



TEM Uluslararası Fiş & Prizler



721.170.150
45x45mm Universal Priz

33,00 TL



721.160.150
45x45mm Amerikan Prizi



721.130.150
45x45mm İngiliz Prizi



721.130.151
51x45mm İngiliz Prizi



721.130.300
İngiliz Fişi

ŞEBEKE TİP

16A 2P+E 200-250 V~



	Açıklama	Ürün Kodu	Çocuk Emniyetli Kod
Kablolu	2'li Şebeke Prizi	310.002.003	310.002.103
	3'lü Şebeke Prizi	310.003.003	310.003.103
	4'lü Şebeke Prizi	310.004.003	310.004.103
Klemensli	2'li Şebeke Prizi	311.002.003	311.002.103
	3'lü Şebeke Prizi	311.003.003	311.003.103
	4'lü Şebeke Prizi	311.004.003	311.004.103
Çift Klemensli	2'li Şebeke Prizi	312.002.003	312.002.103
	3'lü Şebeke Prizi	312.003.003	312.003.103
	4'lü Şebeke Prizi	312.004.003	312.004.103

UPS TİP

16A 2P+E 200-250 V~



	Açıklama	Ürün Kodu	Çocuk Emniyetli Kod
Kablolu	2'li UPS Prizi	320.002.002	320.002.102
	3'lü UPS Prizi	320.003.002	320.003.102
	4'lü UPS Prizi	320.004.002	320.004.102
Klemensli	2'li UPS Prizi	321.002.002	321.002.102
	3'lü UPS Prizi	321.003.002	321.003.102
	4'lü UPS Prizi	321.004.002	321.004.102
Çift Klemensli	2'li UPS Prizi	322.002.002	322.002.102
	3'lü UPS Prizi	322.003.002	322.003.102
	4'lü UPS Prizi	322.004.002	322.004.102

FRANSIZ TİP

16A 2P+E 200-250 V~



	Açıklama	Ürün Kodu
Kablolu	2'li Fransız Prizi	350.002.102
	3'lü Fransız Prizi	350.003.102
	4'lü Fransız Prizi	350.004.102
Klemensli	2'li Fransız Prizi	351.002.102
	3'lü Fransız Prizi	351.003.102
	4'lü Fransız Prizi	351.004.102
Çift Klemensli	2'li Fransız Prizi	352.002.102
	3'lü Fransız Prizi	352.003.102
	4'lü Fransız Prizi	352.004.102

BİLGİSAYAR IEC TİP 10A 2P+E 200-250 V~

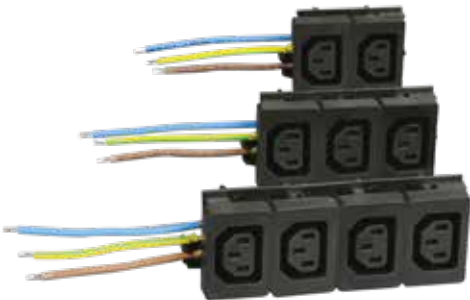

Açıklama	Ürün Kodu
2'li Bilgisayar Prizi	330.002.004
3'lü Bilgisayar Prizi	330.003.004
4'lü Bilgisayar Prizi	330.004.004

İNGİLİZ TİP

13A 2P+E 200-250 V~

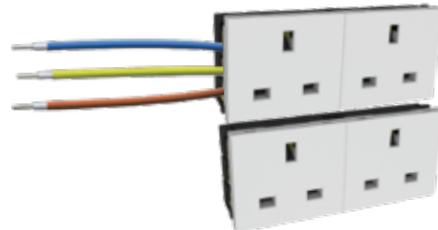

	Açıklama	Ürün Kodu
Kablolu	2'li İngiliz Prizi	340.002.003
	3'lü İngiliz Prizi	340.003.003
	4'lü İngiliz Prizi	340.004.003
Çift Klemensli	2'li İngiliz Prizi	342.002.003
	3'lü İngiliz Prizi	342.003.003
	4'lü İngiliz Prizi	342.004.003



720.130.150
IEC C13 10A
Tırnaklı Gövde Priz



720.130.160
IEC C13 10A
Vidalı Gövde Priz



720.130.200
IEC C13 10A
Seyyar Priz



720.140.320
IEC C14 10A
Tırnaklı Gövde Fiş



720.140.340
IEC C14 10A
Vidalı Gövde Fiş



720.140.300
IEC C14 10A
Seyyar Fiş



720.140.321
IEC C14 10A
Gövdede Fiş



720.190.150
IEC C19 16A
Tırnaklı Gövde Priz



720.190.160
IEC C19 16A
Vidalı Gövde Priz



720.190.200
IEC C19 16A
Seyyar Priz



720.200.320
IEC C20 16A
Tırnaklı Gövde Fiş



720.240.340
IEC C20 16A
Vidalı Gövde Fiş



720.200.300
IEC C20 16A
Seyyar Fiş



720.200.321
IEC C20 16A
Gövdede Fiş



724.021.000
Seyyar Gst Soket
Dişi / Erkek



724.011.000
Seyyar Gst Soket
Dişi / Erkek



724.020.000
GST Soket Dişi



724.010.000
GST Soket Erkek

724.000.010
Plastik Kilit



2.5mm² Soket Klemensler



720.400.200 - Beyaz
720.400.201 - Siyah
720.400.202 - Kırmızı
Erkek - Dişi Takım Soketler



720.500.002 2'li
Klemens



720.500.003 3'lü
Klemens



720.500.004 4'lü
Klemens



720.500.005 5'li
Klemens

tem SPD 0120 TİP 3 Gerilim Koruma

U_c : 255V - 50-60 Hz

U_{oc} : 5/10 kV

I_n : 2,5/5 kA

U_p : $\leq 1,5$ kV



22.5x45mm
734.612.0120.X
SPD 0120-1(Siyah - Beyaz)



45x45mm
734.613.0120.X
SPD 0120-1(Siyah - Beyaz)

Not: Ürünün üzerindeki gösterge ışığı
Yeşil yanıyor ise, ürünün normal çalıştığı,
Kırmızı yanıyor ise, ürünün değiştirilmesi gerektiği anlaşılmalıdır.

X = 0 Beyaz

X = 1 Siyah

tem SPD 1119 TİP 3 Gerilim Koruma

U_c : 255V - 50-60 Hz

U_{oc} : 5 kV

I_n : 3 kA

U_p : ≤ 2 kV



45x45mm
734.613.1119.X
SPD 0120-1(Siyah - Beyaz)

tem SPD 1119-N TİP 3 Gerilim Koruma

U_c : 255V - 50-60 Hz

U_{oc} : 5 kV

U_p : 3 kA

I_n : ≤ 2 kV



45x45mm
734.613.1119.XN
SPD 0120-1(Siyah - Beyaz)

Not: Ürünün üzerindeki gösterge ışığı
Yeşil yanıyorsa, ürünün normal çalıştığı,
yanmıyorsa ürünün değiştirilmesi gerektiği anlaşılmalıdır.

Parazit Filtresi: Bilgisayar, telefon ve müzik setleri gibi hassas elektronik cihazları yüksek frekanslı parazit gerilimlerinden korur. Böylece Görüntü ve sese meydana gelen parazit etkili şekilde bastırılır.

X = 0 Beyaz

X = 1 Siyah



TEM Kablosuz Şarj



Ürün Kodu

715.200.13X

USB

5V 2.1A 10,5 W

Kablosuz

5V 5W - 7,5 W

İletim Mesafesi

≤ 8mm
(Önerilen: 2mm / 4mm)

Verimlilik

≥ 73%

Standart

Qi

Şık ve fonksiyonel tasarım

LED güç göstergesi ışığı ile şarj durumunu gösterir.

Kaymaz yüzeyi ile telefonunuzu güvende tutar.

3mm kalınlığa kadar kasa veyahut kılıfla uyumludur..

USB portu ve Kablosuz şarj aynı anda kullanabilme

Aşırı Sıcaklık ve akım koruması

Cihazlarınız için 7,5W'a kadar hızlı kablosuz şarjı destekler.

Yabancı Nesne Algılama (FOOD) özelliği

Renk

X = 1 Siyah 

X = 2 Gri 



715.200.12X
TİP A/C - 30W(max)
45x45mm (Siyah - Beyaz)

X = 0 Beyaz

X = 1 Siyah

22.5x45mm USB Şarj Cihazları



715.200.20X
TİP A - 2.1A
22.5x45mm (Siyah - Beyaz)



715.200.11X
TİP A - 2 A
22.5x45mm (Siyah - Beyaz)



715.200.10X
TİP A - 1 A
22.5x45mm (Siyah - Beyaz)

X = 0 Beyaz

X = 1 Siyah

45x45mm USB Şarj Cihazları



715.100.10X
TİP A/C - 2.1 A
45x45mm (Siyah - Beyaz)



715.100.11X
TİP A/A - 2.1 A
45x45mm (Siyah - Beyaz)

X = 0 Beyaz

X = 1 Siyah

45x45mm Tv Prizler



723.000.150
TV Prizi



723.000.300
TV Prizi Erkek \varnothing 9.52mm



723.000.400
TV Uydu Prizi

VGA Konnektörleri



715.300.001
6+2 Klemens Girişli
22.5x45mm - Faceplate



715.300.002
14+2 Klemens Girişli 22.5x45mm
Hızlı Montaj - Faceplate



715.300.003
Soket Girişli
45x45mm - Faceplate



715.300.004
Soket Girişli
22.5x45mm - Faceplate



715.300.005
15 Klemens Girişli
22.5x45mm - Faceplate



715.300.007
9 Pinli
22.5x45mm Faceplate



715.300.009
B Soket Girişli
45x45mm - Faceplate

RCA & STEREO Konnektörleri



715.500.002
RCA Konnektör 22.5x45mm
Klemensli - Faceplate



715.500.001
RCA Konnektör 22.5x45mm
Klemensli - Faceplate



715.600.001
Stereo Konnektör 22.5x45mm
Klemensli - Faceplate

HDMI Konnektörleri



715.400.001
TİP A Dişi - Dişi 90°
22.5x45mm - Faceplate



715.400.002
TİP A Dişi - Dişi 180°
22.5x45mm - Faceplate



715.400.003
TİP A Dişi - Dişi Üstten
Giriş - Çıkışlı
22.5x45mm - Faceplate

HDMI Konnektör



715.400.008
HDMI Konnektör TİP A Dişi-Dişi
45x45mm - Faceplate

DISPLAY Konnektör



715.700.001
Display Port Konnektör Soket Girişli
45x45mm - Faceplate

XLR Konnektör



715.600.002
XLR Dişi Soket
45x45mm Klemensli - Faceplate

USB Konnektörleri



715.200.004
Standart A
USB AF/AF 90°
22.5x45mm - Faceplate



715.200.005
Standart A
USB AF/AF 180°
22.5x45mm - Faceplate



715.200.006
Standart A
Klemensli
22.5x45mm - Faceplate

USB / HDMI Keystone



715.200.001
Standart B
Dişi - Dişi - Keystone



715.200.002
Standart A
Dişi - Dişi - Keystone



715.200.003
Standart A
Dişi - Dişi Kablolu - Keystone



715.400.004
TİP A Dişi - Dişi
Keystone



715.400.005
TİP A Dişi - Dişi
Kablolu Keystone



710.100.103
45x45mm Yaylı Kapaklı

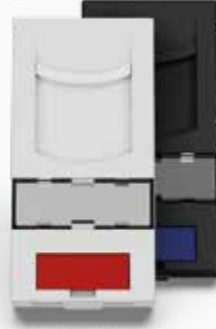

710.100.104
22x45mm Yaylı Kapaklı



710.100.105
45x45mm Yaylı Kapaklı - Çiftli



Telefon -Data Konnektörleri Dişi - Dişi Telefon - Data Konnektörleri



715.100.030
CAT3 TELEFON



715.100.050
CAT5E DATA



715.100.060
CAT6 DATA



715.100.061
CAT6A DATA



715.200.030
CAT3 TELEFON



715.200.050
CAT5E DATA



715.200.060
CAT6 DATA



715.200.061
CAT6A DATA



Telefon Data Fişleri



710.100.350
CAT5 DATA Fişi



710.100.360
CAT6 DATA Fişi



710.100.332 - 2 PIN
710.100.334 - 4 PIN
710.100.336 - 6PIN
TELEFON Fişi





708.100.010
50x50mm - Tekli



708.100.020
50x50mm - Çiftli



709.100.103
45x45mm



709.100.104
22.5x45mm

Kanal Üstü Telefon -Data Kapakları



710.100.107
45x45mm Kapaksız - Çiftli



710.100.111
22.5x45mm Kapaksız - Tekli



710.100.106
45x45mm Kapaksız- Tekli



709.200.104
22x45mm



709.200.103
45x45mm

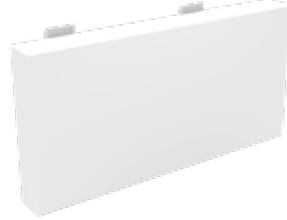

709.200.105
45x90mm

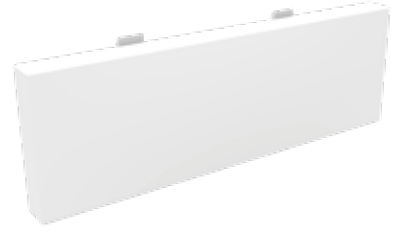

709.200.106
45x135mm

45x45mm Kanal Üstü Keystone Kapakları



710.100.108
Yükseltme Kapağı



710.100.109
Keystone - Faceplate - Tekli



710.100.110
Keystone - Faceplate - Çiftli



tem Akım Koruma

Akım Deęeri : 16A
Voltaj Deęeri : 125/250 V AC
Yalıtım Direnci : >100MOHM (DC 500V)
Koruma Derecesi : IP40



723.225.016
Butonlu Akım Koruma
22.5x45mm



723.225.116
Anahtarlı Akım
Koruma 22.5x45mm

On - Off Anahtarlar



722.045.012
Tekli Anahtar 16A
45x45mm
Işıksız

722.045.112
Tekli Anahtar 16A
45x45mm
Işıklı



722.045.011
Çiftli Anahtar
2x10A 45x45mm
Işıksız

722.045.111
Çiftli Anahtar
2x10A 45x45mm
Işıklı



722.225.010
Anahtar 10A
22.5x45mm
Işıksız

722.225.110
Anahtar 10A
22.5x45mm
Işıklı



722.225.021
Anahtar 16A
22.5x45mm
Işıksız



722.045.022
Çift Anahtar 2x16A
45x45mm
Işıksız



722.225.112
Anahtar 16A
22.5x45mm
Işıklı



722.045.122
Çift Anahtar 2x16A
45x45mm
Işıklı



Bluetooth 5.0

Android - IOS Uyumlu

Sinyal Gürültü Oranı : 95DB

Çalışma Sıcaklığı : 10 - 40 °C

Çalışma Nemi : 35 ~ 85%

İletişim Uzaklığı : 10m

Frekans Tepkisi : 120Hz - 18KHz



TEM Bluetooth Hoparlör

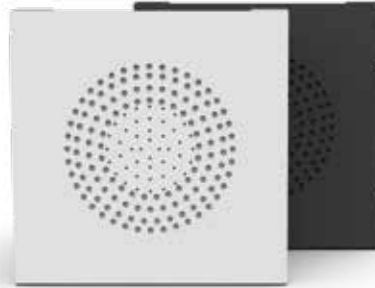

715.200.12X
240V AC / 50-60Hz 0.3A
45x45mm (Siyah - Beyaz)

X = 3 Beyaz

X = 4 Siyah

Örnek Ürünler



1620.1200.11101
2 Şebeke + 2'li USB Şarj
+ Bluetooth Hoparlör + 450cm Profil



1620.1200.1182101
2 Şebeke + 2 Cat6 + 2'li USB Şarj
+ Bluetooth Hoparlör + 500cm Profil



1620.1300.11101
3 Şebeke + 2'li USB Şarj
+ Bluetooth Hoparlör + 550cm Profil

HDMI Kabloları	Ürün Kodu	Uzunluk	Açıklama
	725.400.001	1.5 m	-
	725.400.003	3 m	-
	725.400.005	5 m	-
	725.400.010	10 m	-
	725.400.015	15 m	-
	725.400.020	20 m	-
	725.400.025	25 m	Chipset'li
	725.400.030	30 m	Chipset'li
	725.400.040	40 m	Chipset'li
	725.400.050	50 m	Chipset'li

CAT6 KABLoları	Ürün Kodu	Uzunluk	Açıklama
	725.060.001	1 m	UPT 24 AWG
	725.060.002	2 m	UPT 24 AWG
	725.060.003	3 m	UPT 24 AWG
	725.060.005	5 m	UPT 24 AWG
	725.060.007	7 m	UPT 24 AWG
	725.060.008	8 m	UPT 24 AWG
	725.060.010	10 m	UPT 24 AWG
	725.060.015	15 m	UPT 24 AWG
	725.060.020	20 m	UPT 24 AWG
	725.060.030	30 m	UPT 24 AWG
CAT6 UTP 24 AWG LSOH	725.060.040	40 m	UPT 24 AWG

	725.061.001	1 m	FTP 24 AWG
	725.061.002	2 m	FTP 24 AWG
	725.061.003	3 m	FTP 24 AWG
	725.061.005	5 m	FTP 24 AWG
	725.061.007	7 m	FTP 24 AWG
	725.061.008	8 m	FTP 24 AWG
	725.061.010	10 m	FTP 24 AWG
	725.061.015	15 m	FTP 24 AWG
	725.061.020	20 m	FTP 24 AWG
	725.061.030	30 m	FTP 24 AWG
CAT6 S FTP 26 AWG LSOH	725.061.040	40 m	FTP 24 AWG

	725.062.001	1 m	CAT6A - S - FTP 26 AWG
	725.062.002	2 m	CAT6A - S - FTP 26 AWG
	725.062.003	3 m	CAT6A - S - FTP 26 AWG
	725.062.005	5 m	CAT6A - S - FTP 26 AWG
	725.062.007	7 m	CAT6A - S - FTP 26 AWG
	725.062.008	8 m	CAT6A - S - FTP 26 AWG
	725.062.010	10 m	CAT6A - S - FTP 26 AWG
	725.062.015	15 m	CAT6A - S - FTP 26 AWG
	725.062.020	20 m	CAT6A - S - FTP 26 AWG
	725.062.030	30 m	CAT6A - S - FTP 26 AWG
725.062.040	40 m	CAT6A - S - FTP 26 AWG	



TEM RAY PRİZLERİ

Standart Sigorta Rayına Uygun Prizler

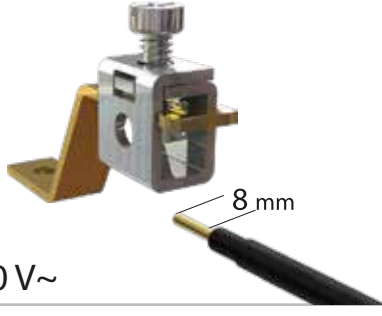

2P+E 200-250 V~

Ray Tipi Monofaze Prizler



217.216.171
Ray Tipi
Şebeke Prizi
Ledli

217.216.170
Ray Tipi
Şebeke Prizi
Ledsiz



217.316.171
Ray Tipi
UPS Prizi
Ledli

217.316.170
Ray Tipi
UPS Prizi
Ledsiz



217.416.171
Ray Tipi
Fransız Prizi
Ledli

217.416.170
Ray Tipi
Fransız Prizi
Ledsiz





Monofaze Prizler

16A

2P+E

200-250 V~

Tek Terminal IP44



216.216.150
Şebeke Pano Prizi



216.316.150
UPS Pano Prizi



216.216.160
Şebeke Pano Prizi



216.316.160
UPS Pano Prizi



217.216.160
Fransız Pano Prizi



440.116.160
IP44
Eğik Makine Prizi



670.116.160
IP67 Kilitli Kapaklı
Eğik Makine Prizi



440.116.150
IP44
Makine Prizi



440.116.151
IP44 Dik Kasalı
Duvar Prizi



440.116.152
IP44 Eğik Kasalı
Duvar Prizi



440.116.153
IP44 Eğik Kasalı Duvar Prizi
+ Monofaze Pano Prizi



Monofaze Kauçuk Fiş & Prizler

16A

2P+E

200-250 V~



215.116.200
Seyyar Priz



215.116.301
Düz Uzun Fiş



215.116.300 | 215.316.300
Şebeke Düz Fiş UPS Düz Fiş



215.116.320 | 215.316.320
Şebeke Eğik Fiş UPS Eğik Fiş



215.116.101
Tekli Priz



215.116.102
İkili Grup Priz



215.116.103
Üçlü Grup Priz



215.116.104
Dörtlü Grup Priz



Trifaze Fiş & Prizler 4x25 A

25A

380-415 V~



540.425.300
Fiş



540.425.200
Seyyar Priz



540.425.110
Duvar Prizi Klemensli



540.425.111
1 Ad. Trifaze + 1 Ad. Monofaze
Grup Priz



540.425.121
2 Ad. Trifaze + 1 Ad. Monofaze
Grup Priz



540.425.112
1 Ad. Trifaze + 2 Ad. Monofaze
Grup Priz



540.425.130
3 Ad. Trifaze
Grup Priz



540.425.150
Pano Prizi



540.425.151
Dik Kasalı Duvar Prizi



540.425.152
Eğik Kasalı Duvar Prizi



540.425.153
Eğik Kasalı Duvar Prizi
+ Monofaze Pano Prizi

Kauçuk Trifaze Prizler 3x16 A

16A

IP44

380-415 V~



544.316.300
Fiş



544.316.150
Pano Prizi



544.316.151
Dik Kasalı Duvar Prizi



544.316.152
Eğik Kasalı Duvar Prizi



544.316.153
Eğik Kasalı Duvar Prizi
+ Monofaze Pano Prizi

Kauçuk Trifaze Prizler 3x32 A

32A

IP44

380-415 V~



544.332.300
Fiş



544.332.150
Pano Prizi



544.332.151
Dik Kasalı Duvar Prizi



544.332.152
Eğik Kasalı Duvar Prizi



544.332.153
Eğik Kasalı Duvar Prizi
+ Monofaze Pano Prizi

3 Kutup

16A

4h

2P+E

IP44

110-130 V~



3 Kutup

16A

6h

2P+E

IP44

200-250 V~



3 Kutup

32A

6h

2P+E

200-250 V~



4 Kutup

16A

6h

3P+E

380-415 V~



446.416.150 
IP44 Pano Prizi



446.416.160 
IP44 Pano Prizi



446.416.151 
IP44 Dik Kasalı Duvar Prizi



446.416.152 
IP44 Eğik Kasalı Duvar Prizi



446.416.153 
IP44 Eğik Kasalı Duvar Prizi
+ Monofaze Priz



446.416.200 
IP44 Seyyar Priz



446.416.300 
IP44 Fiş



676.416.160 
IP67 Kilitli Kapaklı Pano Prizi



676.416.161 
Kilitli Kapaklı Dik Kasalı Duvar Prizi



676.416.200 
Kilitli Kapaklı Seyyar Priz



676.416.300 
Kilitli Fiş

4 Kutup

32A

6h

3P+E

380-415 V~



446.432.150 
IP44 Pano Prizi



446.432.151 
IP44 Dik Kasalı Duvar Prizi



446.432.400 
IP44 Eğik Duvar Prizi



446.432.200 
IP44 Seyyar Priz



446.432.300 
IP44 Fiş



446.432.330 
IP44 Makine
Fişi



446.432.331 
IP44 Düz
Kasalı Makine Fişi



446.432.332 
IP44 Eğik Kasalı
Makine Fişi



446.432.333 
IP44 Eğik Kasalı Makine Fişi
+ Monofaze Pano Prizi

4 Kutup

32A

6h

3P+E

380-415 V~



676.432.150 12
IP67 Kilitli Kapaklı Pano Prizi



676.432.151 6
IP67 Kilitli Kapaklı Dik Kasalı Duvar Prizi



676.432.300 12
IP67 Kilitli Fiş

4 Kutup

63A

6h

3P+E

380-415 V~



446.463.150 6
IP44 Pano Prizi



446.463.200 6
IP44 Seyyar Priz



446.463.300 6
IP44 Fiş



676.463.150 6
IP67 Kilitli Kapaklı Pano Prizi



676.463.200 4
IP67 Kilitli Seyyar Priz



676.463.300 4
IP67 Kilitli Fiş

5 Kutup

16A

6h

3P+N+E

380-415 V~



446.516.150 12
IP44 Pano Prizi



446.516.151 12
IP44 Dik Kasalı Duvar Prizi



446.516.152 4
IP44 Eğik Kasalı Duvar Prizi



446.516.153 4
IP44 Eğik Kasalı Duvar Prizi
+ Monofaze Priz



446.516.400 12
IP44 Eğik Duvar Prizi



446.516.200 12
IP44 Seyyar Priz



446.516.300 12
IP44 Fiş



446.516.320 12
IP44 Eğik Fiş

5 Kutup

16A

6h

3P+N+E

380-415 V~



446.516.330 
IP44 Makine Fişi



446.516.331 
IP44 Düz Kasalı Makine Fişi

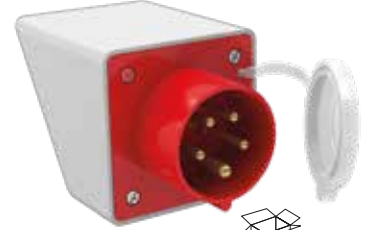

446.516.332 
IP44 Eğik Kasalı Makine Fişi

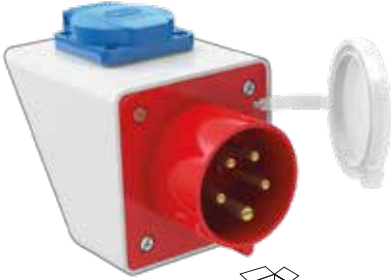

446.516.333 
IP44 Eğik Kasalı Makine Fişi
+ Monofaze Pano Prizi



676.516.150 
IP67 Kilitli Kapaklı Pano Prizi



676.516.151 
Kilitli Kapaklı Dik Kasalı Duvar Prizi



676.516.152 
Kilitli Kapaklı Eğik Kasalı
Duvar Prizi



676.516.153 
Kilitli Kapaklı Eğik Kasalı Duvar Prizi
+ Monofaze Pano Prizi



676.516.300 
Kilitli Fiş

5 Kutup

32A

6h

3P+N+E

380-415 V~



446.532.150 
IP44 Pano Prizi



446.532.151 
IP44 Dik Kasalı Duvar Prizi



446.532.200 
IP44 Seyyar Priz



446.532.300 
IP44 Fiş

5 Kutup

32A

6h

3P+N+E

380-415 V~



446.532.330 
IP44 Makine Fişi



446.532.331 
IP44 Düz Kasalı Makine Fişi



446.532.332 
IP44 Eğik Kasalı Makine Fişi

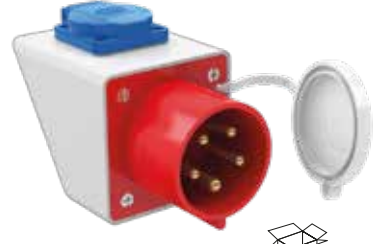

446.532.333 
IP44 Eğik Kasalı Makine Fişi
+ Monofaze Pano Prizi



676.532.150 
IP67 Kilitli Kapaklı Pano Prizi



676.532.151 
Kilitli Kapaklı Dik Kasalı Duvar Prizi



676.532.300 
Kilitli Fiş

5 Kutup

63A

6h

3P+N+E

380-415 V~



446.563.150 
IP44 Pano Prizi



446.563.200 
IP44 Seyyar Priz



446.563.300 
IP44 Fiş



676.563.150 
IP67 Kilitli Kapaklı Pano Prizi



676.563.200 
IP67 Kilitli Seyyar Priz



676.563.300 
IP67 Kilitli Fiş

Seyyar 3'lü Çoklayıcı Prizler (Fiş Girişli)

IP44

6h

50/60 Hz.



Ürün Kodu	Kutup	I(A)	Volt	Renk	
1344.316.333.0	2P+E	16	200-250	◆	2
1344.332.333.0	2P+E	32	200-250	◆	4
1344.416.333.0	3P+E	16	380-415	◆	2
1344.432.333.0	3P+E	32	380-415	◆	2
1344.516.333.0	3P+N+E	16	380-415	◆	2
1344.532.333.0	3P+N+E	32	380-415	◆	2

Seyyar 3'lü Çoklayıcı Prizler (Fiş Girişli)

IP67

6h

50/60 Hz.



Ürün Kodu	Kutup	I(A)	Volt	Renk	
1367.316.333.0	2P+E	16	200-250	◆	2
1367.332.333.0	2P+E	32	200-250	◆	4
1367.416.333.0	3P+E	16	380-415	◆	2
1367.432.333.0	3P+E	32	380-415	◆	2
1367.516.333.0	3P+N+E	16	380-415	◆	2
1367.532.333.0	3P+N+E	32	380-415	◆	2

Seyyar 3'lü Çoklayıcı Prizler (Rekor Girişli)

IP44

6h

50/60 Hz.



Ürün Kodu	Kutup	I(A)	Volt	Renk	
1344.316.333.1	2P+E	16	200-250	◆	2
1344.332.333.1	2P+E	32	200-250	◆	4
1344.416.333.1	3P+E	16	380-415	◆	2
1344.432.333.1	3P+E	32	380-415	◆	2
1344.516.333.1	3P+N+E	16	380-415	◆	4
1344.532.333.1	3P+N+E	32	380-415	◆	4

Seyyar 3'lü Çoklayıcı Prizler (Rekor Girişli)

IP67

6h

50/60 Hz.



Ürün Kodu	Kutup	I(A)	Volt	Renk	
1367.316.333.1	2P+E	16	200-250	◆	2
1367.332.333.1	2P+E	32	200-250	◆	4
1367.416.333.1	3P+E	16	380-415	◆	2
1367.432.333.1	3P+E	32	380-415	◆	2
1367.516.333.1	3P+N+E	16	380-415	◆	4
1367.532.333.1	3P+N+E	32	380-415	◆	4

Dik Pano Prizleri (75x75)

IP44

6h

50/60 Hz.



Ürün Kodu	Kutup	I(A)	Volt	Renk	
446.316.180	2P+E	16	200-250	◆	10
446.332.180	2P+E	32	200-250	◆	5
446.416.180	3P+E	16	380-415	◆	10
446.432.180	3P+E	32	380-415	◆	5
446.516.180	3P+N+E	16	380-415	◆	8
446.532.180	3P+N+E	32	380-415	◆	5

Eğik Pano Prizleri



Ürün Kodu	Kutup	I(A)	Volt	Renk	
446.316.190	2P+E	16	200-250	◆	10
446.332.190	2P+E	32	200-250	◆	5
446.416.190	3P+E	16	380-415	◆	10
446.432.190	3P+E	32	380-415	◆	5
446.516.190	3P+N+E	16	380-415	◆	8
446.532.190	3P+N+E	32	380-415	◆	5

Seyyar Prizler



Ürün Kodu	Kutup	I(A)	Volt	Renk	
446.316.240	2P+E	16	200-250	◆	10
446.332.240	2P+E	32	200-250	◆	4
446.416.240	3P+E	16	380-415	◆	10
446.432.240	3P+E	32	380-415	◆	4
446.516.240	3P+N+E	16	380-415	◆	5
446.532.240	3P+N+E	32	380-415	◆	3

Seyyar Fişler



Ürün Kodu	Kutup	I(A)	Volt	Renk	
446.316.340	2P+E	16	200-250	◆	10
446.332.340	2P+E	32	200-250	◆	5
446.416.340	3P+E	16	380-415	◆	10
446.432.340	3P+E	32	380-415	◆	5
446.516.340	3P+N+E	16	380-415	◆	8
446.532.340	3P+N+E	32	380-415	◆	4

Eğik Duvar Prizleri



Ürün Kodu	Kutup	I(A)	Volt	Renk	
446.316.410	2P+E	16	200-250	◆	3
446.332.410	2P+E	32	200-250	◆	2
446.416.410	3P+E	16	380-415	◆	3
446.432.410	3P+E	32	380-415	◆	2
446.516.410	3P+N+E	16	380-415	◆	3
446.532.410	3P+N+E	32	380-415	◆	2

Dik Pano Prizleri (75x75)

IP67

6h

50/60 Hz.



Ürün Kodu	Kutup	I(A)	Volt	Renk	
676.316.180	2P+E	16	200-250	◆	8
676.332.180	2P+E	32	200-250	◆	5
676.416.180	3P+E	16	380-415	◆	8
676.432.180	3P+E	32	380-415	◆	5
676.516.180	3P+N+E	16	380-415	◆	8
676.532.180	3P+N+E	32	380-415	◆	5

Eğik Pano Prizleri



Ürün Kodu	Kutup	I(A)	Volt	Renk	
676.316.190	2P+E	16	200-250	◆	10
676.332.190	2P+E	32	200-250	◆	5
676.416.190	3P+E	16	380-415	◆	8
676.432.190	3P+E	32	380-415	◆	5
676.516.190	3P+N+E	16	380-415	◆	8
676.532.190	3P+N+E	32	380-415	◆	5

Seyyar Prizler



Ürün Kodu	Kutup	I(A)	Volt	Renk	
676.316.240	2P+E	16	200-250	◆	10
676.332.240	2P+E	32	200-250	◆	4
676.416.240	3P+E	16	380-415	◆	8
676.432.240	3P+E	32	380-415	◆	4
676.516.240	3P+N+E	16	380-415	◆	4
676.532.240	3P+N+E	32	380-415	◆	3

Seyyar Fişler



Ürün Kodu	Kutup	I(A)	Volt	Renk	
676.316.340	2P+E	16	200-250	◆	10
676.332.340	2P+E	32	200-250	◆	4
676.416.340	3P+E	16	380-415	◆	8
676.432.340	3P+E	32	380-415	◆	4
676.516.340	3P+N+E	16	380-415	◆	6
676.532.340	3P+N+E	32	380-415	◆	3

Eğik Duvar Prizleri



Ürün Kodu	Kutup	I(A)	Volt	Renk	
676.316.410	2P+E	16	200-250	◆	3
676.332.410	2P+E	32	200-250	◆	2
676.416.410	3P+E	16	380-415	◆	3
676.432.410	3P+E	32	380-415	◆	2
676.516.410	3P+N+E	16	380-415	◆	3
676.532.410	3P+N+E	32	380-415	◆	2

İçten Kilitli Şalterli Pano Prizi (Yatay Tip)

IP44

6h

50/60 Hz.



Ürün Kodu	Kutup	I(A)	Volt	Renk	
1444.316.15	2P+E	16	200-250	◆	1
1444.332.15	2P+E	32	200-250	◆	1
1444.416.15	3P+E	16	380-415	◆	1
1444.432.15	3P+E	32	380-415	◆	1
1444.516.15	3P+N+E	16	380-415	◆	1
1444.532.15	3P+N+E	32	380-415	◆	1

İçten Kilitli Şalterli Pano Prizi (Yatay Tip)

IP67

6h

50/60 Hz.



Ürün Kodu	Kutup	I(A)	Volt	Renk	
1467.316.15	2P+E	16	200-250	◆	1
1467.332.15	2P+E	32	200-250	◆	1
1467.416.15	3P+E	16	380-415	◆	1
1467.432.15	3P+E	32	380-415	◆	1
1467.516.15	3P+N+E	16	380-415	◆	1
1467.532.15	3P+N+E	32	380-415	◆	1

İçten Kilitli Şalterli Duvar Prizi (Yatay Tip)

IP44

6h

50/60 Hz.



Ürün Kodu	Kutup	I(A)	Volt	Renk	
1444.316.10	2P+E	16	200-250	◆	1
1444.332.10	2P+E	32	200-250	◆	1
1444.416.10	3P+E	16	380-415	◆	1
1444.432.10	3P+E	32	380-415	◆	1
1444.516.10	3P+N+E	16	380-415	◆	1
1444.532.10	3P+N+E	32	380-415	◆	1

İçten Kilitli Şalterli Duvar Prizi (Yatay Tip)

IP67

6h

50/60 Hz.



Ürün Kodu	Kutup	I(A)	Volt	Renk	
1467.316.10	2P+E	16	200-250	◆	1
1467.332.10	2P+E	32	200-250	◆	1
1467.416.10	3P+E	16	380-415	◆	1
1467.432.10	3P+E	32	380-415	◆	1
1467.516.10	3P+N+E	16	380-415	◆	1
1467.532.10	3P+N+E	32	380-415	◆	1

İçten Kilitli Şalterli Pano Prizi (Dikey Tip)

IP44

6h

50/60 Hz.



Ürün Kodu	Kutup	I(A)	Volt	Renk	
1944.316.15	2P+E	16	200-250	◆	1
1944.332.15	2P+E	32	200-250	◆	1
1944.416.15	3P+E	16	380-415	◆	1
1944.432.15	3P+E	32	380-415	◆	1
1944.516.15	3P+N+E	16	380-415	◆	1
1944.532.15	3P+N+E	32	380-415	◆	1

İçten Kilitli Şalterli Pano Prizi (Dikey Tip)

IP67

6h

50/60 Hz.



Ürün Kodu	Kutup	I(A)	Volt	Renk	
1967.316.15	2P+E	16	200-250	◆	1
1967.332.15	2P+E	32	200-250	◆	1
1967.416.15	3P+E	16	380-415	◆	1
1967.432.15	3P+E	32	380-415	◆	1
1967.516.15	3P+N+E	16	380-415	◆	1
1967.532.15	3P+N+E	32	380-415	◆	1

İçten Kilitli Şalterli Duvar Prizi (Dikey Tip)

IP44

6h

50/60 Hz.



Ürün Kodu	Kutup	I(A)	Volt	Renk	
1944.316.10	2P+E	16	200-250	◆	1
1944.332.10	2P+E	32	200-250	◆	1
1944.416.10	3P+E	16	380-415	◆	1
1944.432.10	3P+E	32	380-415	◆	1
1944.516.10	3P+N+E	16	380-415	◆	1
1944.532.10	3P+N+E	32	380-415	◆	1

İçten Kilitli Şalterli Duvar Prizi (Dikey Tip)

IP67

6h

50/60 Hz.



Ürün Kodu	Kutup	I(A)	Volt	Renk	
1967.316.10	2P+E	16	200-250	◆	1
1967.332.10	2P+E	32	200-250	◆	1
1967.416.10	3P+E	16	380-415	◆	1
1967.432.10	3P+E	32	380-415	◆	1
1967.516.10	3P+N+E	16	380-415	◆	1
1967.532.10	3P+N+E	32	380-415	◆	1

İçten Kilitli Şalterli Sigortalı Pano Prizi

IP44

6h

50/60 Hz.



Ürün Kodu	Kutup	I(A)	Volt	Renk	
1644.316.15	2P+E	16	200-250	◆	1
1644.332.15	2P+E	32	200-250	◆	1
1644.416.15	3P+E	16	380-415	◆	1
1644.432.15	3P+E	32	380-415	◆	1
1644.516.15	3P+N+E	16	380-415	◆	1
1644.532.15	3P+N+E	32	380-415	◆	1

İçten Kilitli Şalterli Sigortalı Pano Prizi

IP67

6h

50/60 Hz.



Ürün Kodu	Kutup	I(A)	Volt	Renk	
1667.316.15	2P+E	16	200-250	◆	1
1667.332.15	2P+E	32	200-250	◆	1
1667.416.15	3P+E	16	380-415	◆	1
1667.432.15	3P+E	32	380-415	◆	1
1667.516.15	3P+N+E	16	380-415	◆	1
1667.532.15	3P+N+E	32	380-415	◆	1

İçten Kilitli Şalterli Sigortalı Duvar Prizi

IP44

6h

50/60 Hz.



Ürün Kodu	Kutup	I(A)	Volt	Renk	
1644.316.10	2P+E	16	200-250	◆	1
1644.332.10	2P+E	32	200-250	◆	1
1644.416.10	3P+E	16	380-415	◆	1
1644.432.10	3P+E	32	380-415	◆	1
1644.516.10	3P+N+E	16	380-415	◆	1
1644.532.10	3P+N+E	32	380-415	◆	1

İçten Kilitli Şalterli Sigortalı Duvar Prizi

IP67

6h

50/60 Hz.



Ürün Kodu	Kutup	I(A)	Volt	Renk	
1667.316.10	2P+E	16	200-250	◆	1
1667.332.10	2P+E	32	200-250	◆	1
1667.416.10	3P+E	16	380-415	◆	1
1667.432.10	3P+E	32	380-415	◆	1
1667.516.10	3P+N+E	16	380-415	◆	1
1667.532.10	3P+N+E	32	380-415	◆	1

**260x350mm Priz Montajlı Sigortalı Kombinasyon Kutuları
(12 Sigorta Kapasiteli)**

HALOJEN FREE

Ürün Kodu

IP44 Kombinasyon Kutuları



351.0012.0000.000	260x350x120mm IP44 Boş Kombinasyon Kutusu
351.4160.1160.224	2 Ad. IP44 4x16A CEE + 2 Ad. IP44 1x16A Ön + 4 Ad. IP44 1x16A Yan
351.0000.4160.042	4 Ad. IP44 4x16A CEE Ön + 2 Ad.1x16 Yan
351.0000.3163.044	4 Ad. IP44 3x16A Ön + 4 Ad. 1x16 Yan
351.3323.3163.224	2 Ad. IP44 3x32A Ön + 2 Ad. IP44 3x16 Ön + 4 Ad. 1x16A Yan
351.0000.3323.044	4 Ad. IP44 3x32A Ön + 4 Ad. 1x16A Yan
351.4320.4250.222	2 Ad. IP44 4x32A CEE Ön + 2 Ad. IP44 4x25A Ön + 2 Ad. 1x16A Yan
351.0000.4250.044	4 Ad. IP44 4x25A Ön + 4 Ad. 1x16A Yan
351.0000.4320.046	4 Ad. IP44 4x32A CEE Ön + 6 Ad. 1x16A Yan
351.0000.4321.044	4 Ad. IP67 4x32A CEE Ön + 4 Ad. 1x16A Yan
351.4631.4321.222	2 Ad. IP67 4x63A CEE Ön + 2 Ad. IP67 4x32A CEE Ön + 2 Ad. 1x16 Yan
351.0000.4630.028	2 Ad. IP44 4x63A CEE Ön + 4 Ad. 1x16A Ön + 4 Ad. 1x16 Yan
351.5320.5160.222	2 Ad. IP44 5x32A CEE Ön + 2 Ad. IP44 5x16A CEE Ön + 2 Ad. 1x16 Yan
351.0000.5321.046	4 Ad. IP67 5x32A CEE Ön + 6 Ad. 1x16A Yan
351.5631.5321.222	2 Ad. IP67 5x63A CEE Ön + 2 Ad. IP67 5x32A CEE Ön + 2 Ad. 1x16A Yan

Ürün Kodu

IP67 Kombinasyon Kutuları



451.0012.0000.000	260x350x120mm IP67 Boş Kombinasyon Kutusu
451.4160.1160.224	2 Ad. IP44 4x16A CEE + 2 Ad. IP44 1x16A Ön + 4 Ad. IP44 1x16A Yan
451.0000.4160.042	4 Ad. IP44 4x16A CEE Ön + 2 Ad. 1x16 Yan
451.0000.3163.044	4 Ad. IP44 3x16A Ön + 4 Ad. 1x16 Yan
451.3323.3163.224	2 Ad. IP44 3x32A Ön + 2 Ad. IP44 3x16 Ön + 4 Ad. 1x16A Yan
451.0000.3323.044	4 Ad. IP44 3x32A Ön + 4 Ad. 1x16A Yan
451.4320.4250.222	2 Ad. IP44 4x32A CEE Ön + 2 Ad. IP44 4x25A Ön + 2 Ad. 1x16A Yan
451.0000.4250.044	4 Ad. IP44 4x25A Ön + 4 Ad. 1x16A Yan
451.0000.4320.046	4 Ad. IP44 4x32A CEE Ön + 6 Ad. 1x16A Yan
451.0000.4321.044	4 Ad. IP67 4x32A CEE Ön + 4 Ad. 1x16A Yan
451.4631.4321.222	2 Ad. IP67 4x63A CEE Ön + 2 Ad. IP67 4x32A CEE Ön + 2 Ad. 1x16 Yan
451.0000.4630.028	2 Ad. IP44 4x63A CEE Ön + 4 Ad. 1x16A Ön + 4 Ad. 1x16 Yan
451.5320.5160.222	2 Ad. IP44 5x32A CEE Ön + 2 Ad. IP44 5x16A CEE Ön + 2 Ad. 1x16 Yan
451.0000.5321.046	4 Ad. IP67 5x32A CEE Ön + 6 Ad. 1x16A Yan
451.5631.5321.222	2 Ad. IP67 5x63A CEE Ön + 2 Ad. IP67 5x32A CEE Ön + 2 Ad. 1x16A Yan



451.0012.0000.000



451.0000.4160.028



451.4160.3160.224



451.5320.5160.224



451.4321.5321.220

**210x280mm Priz Montajlı Sigortalı Kombinasyon Kutuları
(8 Sigorta Kapasiteli - Halojen Free)**

Ürün Kodu

IP44 Kombinasyon Kutuları



352.0008.0000.000	210x280x100mm IP44 Boş Kombinasyon Kutusu
352.0000.4160.011	1 Ad. IP44 4x16A CEE Ön + 1 Ad. 1x16A Ön
352.0000.4160.012	1 Ad. IP44 4x16A CEE Ön + 2 Ad. 1x16A Ön
352.0000.4160.022	2 Ad. IP44 4x16A CEE Ön + 2 Ad. 1x16A Yan
352.0000.4250.021	2 Ad. IP44 4x25A Ön + 1 Ad. 1x16A Yan
352.0000.4250.022	2 Ad. IP44 4x25A Ön + 2 Ad. 1x16A Yan
352.0000.4320.022	2 Ad. IP44 4x32A CEE Ön + 2 Ad. 1x16A Yan
352.0000.4321.024	2 Ad. IP67 4x32A CEE Ön + 4 Ad. 1x16A Yan
352.0000.5160.022	2 Ad. IP44 5x16A CEE Ön + 2 Ad. 1x16A Yan
352.0000.5320.012	1 Ad. IP44 5x32A CEE Ön + 2 Ad. 1x16A Ön
352.0000.5320.022	2 Ad. IP44 5x32A CEE Ön + 2 Ad. 1x16A Yan
352.0000.5321.014	1 Ad. IP67 5x32A CEE Ön + 2 Ad. 1x16A Ön + 2 Ad. 1x16A Yan
352.0000.3163.022	2 Ad. IP44 3x16A Ön + 2 Ad. 1x16A Yan
352.3323.3163.112	1 Ad. IP44 3x32A Ön + 1 Ad. IP44 3x16A Ön + 2 Ad. 1x16A Yan
352.0000.3323.022	2 Ad. IP44 3x32A CEE Ön + 2 Ad. 1x16A Yan

Ürün Kodu

IP67 Kombinasyon Kutuları



452.0008.0000.000	210x280x100mm IP67 Boş Kombinasyon Kutusu
452.0000.4160.011	1 Ad. IP44 4x16A CEE Ön + 1 Ad. 1x16A Ön
452.0000.4160.012	1 Ad. IP44 4x16A CEE Ön + 2 Ad. 1x16A Ön
452.0000.4160.022	2 Ad. IP44 4x16A CEE Ön + 2 Ad. 1x16A Yan
452.0000.4250.021	2 Ad. IP44 4x25A Ön + 1 Ad. 1x16A Yan
452.0000.4250.022	2 Ad. IP44 4x25A Ön + 2 Ad. 1x16A Yan
452.0000.4320.022	2 Ad. IP44 4x32A CEE Ön + 2 Ad. 1x16A Yan
452.0000.4321.024	2 Ad. IP67 4x32A CEE Ön + 4 Ad. 1x16A Yan
452.0000.5160.022	2 Ad. IP44 5x16A CEE Ön + 2 Ad. 1x16A Yan
452.0000.5320.012	1 Ad. IP44 5x32A CEE Ön + 2 Ad. 1x16A Ön
452.0000.5320.022	2 Ad. IP44 5x32A CEE Ön + 2 Ad. 1x16A Yan
452.0000.5321.014	1 Ad. IP67 5x32A CEE Ön + 2 Ad. 1x16A Ön + 2 Ad. 1x16A Yan
452.0000.3163.022	2 Ad. IP44 3x16A Ön + 2 Ad. 1x16A Yan
452.3323.3163.112	1 Ad. IP44 3x32A Ön + 1 Ad. IP44 3x16A Ön + 2 Ad. 1x16A Yan
452.0000.3323.022	2 Ad. IP44 3x32A CEE Ön + 2 Ad. 1x16A Yan



452.0008.0000.000



452.0000.3160.022



452.0000.4160.012



452.0000.4320.022



452.0000.5321.020

**135x250mm Priz Montajlı Sigortalı Kombinasyon Kutuları
(6 Sigorta Kapasiteli - Halojen Free)****Ürün Kodu**

363.0006.0000.000
363.0000.3163.012
363.0000.3323.012
363.0000.4250.012
363.0000.4160.012
363.0000.4320.012
363.0000.5160.012
363.0000.5320.012

IP44 Kombinasyon Kutuları

135x250x120mm IP44 Boş Kombinasyon Kutusu
1 Ad. IP44 3x16A Ön + 2 Ad. 1x16A Yan
1 Ad. IP44 3x32A Ön + 2 Ad. 1x16A Yan
1 Ad. IP44 4x25A Ön + 2 Ad. 1x16A Yan
1 Ad. IP44 4x16A CEE Ön + 2 Ad. 1x16A Yan
1 Ad. IP44 4x32A CEE Ön + 2 Ad. 1x16A Yan
1 Ad. IP44 5x16A CEE Ön + 2 Ad. 1x16A Yan
1 Ad. IP44 5x32A CEE Ön + 2 Ad. 1x16A Yan



363.0000.0000.000

Ürün Kodu

463.0006.0000.000
463.0000.3163.012
463.0000.3323.012
463.0000.4250.012
463.0000.4160.012
463.0000.4320.012
463.0000.5160.012
463.0000.5320.012

IP67 Kombinasyon Kutuları

135x250x120mm IP67 Boş Kombinasyon Kutusu
1 Ad. IP44 3x16A Ön + 2 Ad. 1x16A Yan
1 Ad. IP44 3x32A Ön + 2 Ad. 1x16A Yan
1 Ad. IP44 4x25A Ön + 2 Ad. 1x16A Yan
1 Ad. IP44 4x16A CEE Ön + 2 Ad. 1x16A Yan
1 Ad. IP44 4x32A CEE Ön + 2 Ad. 1x16A Yan
1 Ad. IP44 5x16A CEE Ön + 2 Ad. 1x16A Yan
1 Ad. IP44 5x32A CEE Ön + 2 Ad. 1x16A Yan



463.0000.3321.010

**113x210mm Priz Montajlı Sigortalı Kombinasyon Kutuları
(4 Sigorta Kapasiteli - Halojen Free)****Ürün Kodu**

353.0004.0000.000
353.0000.3163.012
353.0000.3323.012
353.0000.4250.012
353.0000.4160.012
353.0000.4320.012
353.0000.5160.012
353.0000.5320.012

IP44 Kombinasyon Kutuları

113x210x90mm IP44 Boş Kombinasyon Kutusu
1 Ad. IP44 3x16A Ön + 2 Ad. 1x16A Yan
1 Ad. IP44 3x32A Ön + 2 Ad. 1x16A Yan
1 Ad. IP44 4x25A Ön + 2 Ad. 1x16A Yan
1 Ad. 1P44 4x16A CEE Ön + 2 Ad. 1x16A Yan
1 Ad. 1P44 4x32A CEE Ön + 2 Ad. 1x16A Yan
1 Ad. 1P44 5x16A CEE Ön + 2 Ad. 1x16A Yan
1 Ad. 1P44 5x32A CEE Ön + 2 Ad. 1x16A Yan



353.0004.0000.000

Ürün Kodu

453.0004.0000.000
453.0000.3163.012
453.0000.3323.012
453.0000.4250.012
453.0000.4160.012
453.0000.4320.012
453.0000.5160.012
453.0000.5320.012

IP67 Kombinasyon Kutuları

113x210x90mm IP67 Boş Kombinasyon Kutusu
1 Ad. IP44 3x16A Ön + 2 Ad. 1x16A Yan
1 Ad. IP44 3x32A Ön + 2 Ad. 1x16A Yan
1 Ad. IP44 4x25A Ön + 2 Ad. 1x16A Yan
1 Ad. 1P44 4x16A CEE Ön + 2 Ad. 1x16A Yan
1 Ad. 1P44 4x32A CEE Ön + 2 Ad. 1x16A Yan
1 Ad. 1P44 5x16A CEE Ön + 2 Ad. 1x16A Yan
1 Ad. 1P44 5x32A CEE Ön + 2 Ad. 1x16A Yan



453.0000.4320.012

**113x210mm Priz Montajlı Sigortalı Kombinasyon Kutuları
(4 Sigorta Kapasiteli - Halojen Free)****Ürün Kodu IP44 Kombinasyon Kutuları**

454.0004.0000.000	113x210x90mm IP44 Boş Kombinasyon Kutusu
454.0000.3320.012	1 Ad. IP44 3x32A CEE Ön + 2 Ad. 1x16A Yan
454.0000.4160.012	1 Ad. IP44 4x16A CEE Ön + 2 Ad. IP44 1x16A Yan
454.0000.3163.012	1 Ad. IP44 3x16A Ön + 2 Ad. 1x16A Yan
454.0000.3323.012	1 Ad. IP44 3x32A Ön + 2 Ad. 1x16A Yan



454.0004.0000.000



454.0000.3320.012



454.0000.4160.012



454.0000.5320.012

454.0000.4321.010

**Priz Montajlı Sigortasız Kombinasyon Kutuları
(Halojen Free)****Ürün Kodu IP44 Kombinasyon Kutuları**

355.0000.0000.000	210x280x100mm IP44 Boş Kombinasyon Kutusu	1
355.4320.4160.224	2 Ad. IP44 4x32A CEE Ön + 2 Ad. IP44 4x16A CEE Ön + 4 Ad. 1x16A Yan	1
355.4320.5160.220	2 Ad. IP44 4x32A CEE Ön + 2 Ad. IP44 5x16A CEE Ön	1
356.0000.0000.000	113x113x73mm IP44 Boş Kombinasyon Kutusu	6
356.0000.4160.012	1 Ad. IP44 4x16A CEE Ön + 2 Ad. 1x16A Yan	6
356.0000.5160.012	1 Ad. IP44 5x16A CEE Ön + 2 Ad. 1x16A Yan	6
357.0000.0000.000	210x113x73mm IP44 Boş Kombinasyon Kutusu	3
357.0000.4320.022	2 Ad. IP44 4x32A CEE Ön + 2 Ad. 1x16A Yan	3
357.0000.5320.022	2 Ad. IP44 5x32A CEE Ön + 2 Ad. 1x16A Yan	3

Ürün Kodu IP67 Kombinasyon Kutuları

455.0000.0000.000	210x280x100mm IP67 Boş Kombinasyon Kutusu	1
455.4321.4161.224	2 Ad. IP67 4x32A CEE Ön + 2 Ad. IP67 4x16A CEE Ön + 4 Ad. 1x16A Yan	1
455.4320.5160.220	2 Ad. IP44 4x32A CEE Ön + 2 Ad. IP44 5x16A CEE Ön	1
456.0000.0000.000	113x113x73mm IP67 Boş Kombinasyon Kutusu	6
456.0000.4160.012	1 Ad. IP44 4x16A CEE Ön + 2 Ad. 1x16A Yan	6
456.0000.5160.012	1 Ad. IP44 5x16A CEE Ön + 2 Ad. 1x16A Yan	6
457.0000.0000.000	210x113x73mm IP67 Boş Kombinasyon Kutusu	3
457.0000.4320.022	2 Ad. IP44 4x32A CEE Ön + 2 Ad. 1x16A Yan	3
457.0000.5320.022	2 Ad. IP44 5x32A CEE Ön + 2 Ad. 1x16A Yan	3



455.0000.0000.000



455.0000.4160.028



455.4160.4320.224



457.0000.5320.022



456.0000.4160.012

Küçük Boy Taşıyıcı Ayak

Ürün Kodu

740.022.001

Açıklama

(351 - 451 - 352 - 452 - 361) Kombinasyonlar
+ (21x30 - 26x35 30x40) Panolar

Ölçü (mm)

310x610



Büyük Boy Taşıyıcı Ayak

Ürün Kodu

740.022.002

Açıklama

(40x50 - 40x60 - 50x70) Panolar

Ölçü (mm)

510x1010



Opak Kapaklı Termoplastik Buatlar

HALOJEN FREE

IP44 Ürün Kodu	IP67 Ürün Kodu	Dış Ölçü(mm)	
344.041.101	-	85 x 85 x 41	24
344.055.201	367.055.201	95 x 95 x 55	12
344.073.301	367.073.301	113 x 113 x 73	12
344.120.301	367.120.301	113 x 113 x 120	6
344.073.401	367.073.401	113 x 210 x 73	6
344.120.401	367.120.401	113 x 210 x 120	3
344.085.421	367.085.421	130 x 245 x 85	2
344.140.421	367.140.421	130 x 245 x 140	2
344.100.501	367.100.501	210 x 280 x 100	1
344.135.601	367.135.601	210 x 280 x 135	1
344.115.501	367.115.501	260 x 350 x 115	1
344.145.601	367.145.601	260 x 350 x 145	1
344.155.601	367.155.601	260 x 350 x 155	1
344.185.601	367.185.601	260 x 350 x 185	1



367.073.301



367.073.401



367.100.501



367.135.601



367.155.601

Şeffaf Kapaklı Termoplastik Buatlar

HALOJEN FREE

IP44 Ürün Kodu	IP67 Ürün Kodu	Dış Ölçü(mm)	
344.055.202	367.055.202	95 x 95 x 55	12
344.073.302	367.073.302	113 x 113 x 73	12
344.120.302	367.120.302	113 x 113 x 120	6
344.073.402	367.073.402	113 x 210 x 73	6
344.120.402	367.120.402	113 x 210 x 120	3
344.085.422	367.085.422	130 x 245 x 85	2
344.140.422	367.140.422	130 x 245 x 140	2
344.100.502	367.100.502	210 x 280 x 100	1
344.135.602	367.135.602	210 x 280 x 135	1
344.115.502	367.115.502	260 x 350 x 115	1
344.145.602	367.145.602	260 x 350 x 145	1
344.155.602	367.155.602	260 x 350 x 155	1
344.185.602	367.185.602	260 x 350 x 185	1



367.073.302



367.073.402



367.100.502



367.135.602



367.155.602

Taban Saclı

IP65

HALOJEN FREE

Ürün Kodu		Ölçü(cm)	
Opak Kapak	Şeffaf Kapak		
910.2130.131.000	910.2130.132.000	21 x 30 x 13	20
910.2635.151.000	910.2635.152.000	26 x 35 x 15	12
910.2635.181.000	910.2635.182.000	26 x 35 x 18	12
910.3040.131.000	910.3040.132.000	30 x 40 x 13	10
910.3040.171.000	910.3040.172.000	30 x 40 x 17	8
910.3040.191.000	910.3040.192.000	30 x 40 x 19	8
910.3040.231.000	910.3040.232.000	30 x 40 x 23	8
910.4050.201.000	910.4050.202.000	40 x 50 x 20	6
910.4060.201.000	910.4060.202.000	40 x 60 x 20	6
910.5070.251.000	910.5070.252.000	50 x 70 x 25	4



910.2130.132.000



910.2635.151.000



910.3040.232.000



910.4050.201.000

Perdeli

IP65

HALOJEN FREE

Ürün Kodu		Ölçü(cm)	Açıklama	
Opak Kapak	Şeffaf Kapak			
920.2130.131.016	920.2130.132.016	21 x 30 x 13	2 x 8 Sigorta	20
920.2635.151.018	920.2635.152.018	26 x 35 x 15	2 x 9 Sigorta	12
920.3040.131.024	920.3040.132.024	30 x 40 x 13	3 x 8 Sigorta	10
920.3040.171.024	920.3040.172.024	30 x 40 x 17	3 x 8 Sigorta	8
920.4050.201.048	920.4050.202.048	40 x 50 x 20	3 x 16 Sigorta	6
920.4060.201.064	920.4060.202.064	40 x 60 x 20	4 x 16 Sigorta	6
920.5070.251.100	920.5070.252.100	50 x 70 x 25	5 x 20 Sigorta	4



920.2635.151.018



920.3040.172.024



920.4050.201.048



920.4060.202.064

Perdeli + Kompakt Şalterli

IP65

HALOJEN FREE

Ürün Kodu		Ölçü(cm)	Açıklama	
Opak Kapak	Şeffaf Kapak			
922.4050.201.032	922.4050.202.032	40 x 50 x 20	2 x 16 Sigorta + 1 Kompakt Şalter	6
922.4060.201.048	922.4060.202.048	40x 60 x 20	3 x 16 Sigorta + 1 Kompakt Şalter	6
922.5070.251.080	922.5070.252.080	50 x 70 x 25	4 x 20 Sigorta + 1 Kompakt Şalter	4



922.4050.202.032



922.4060.201.048



922.5070.252.080

Monofoze Sayaçlı

IP65

HALOJEN FREE

Ürün Kodu		Ölçü(cm)	Açıklama	
Opak Kapak	Şeffaf Kapak			
930.2130.131.003	930.2130.132.003	21 x 30 x 13	1 Sayaç + 3 Sigorta	20
930.2635.151.003	930.2635.152.003	26x 35 x 15	1 Sayaç + 3 Sigorta	12

Monofoze Sayaç+ Dağıtımlı

IP65

HALOJEN FREE

Ürün Kodu		Ölçü(cm)	Açıklama	
Opak Kapak	Şeffaf Kapak			
931.3040.131.013	931.3040.132.013	30 x 40 x 13	1 Sayaç + 13 Sigorta	10
931.3040.171.013	931.3040.172.013	30 x 40 x 17	1 Sayaç + 13 Sigorta	8
931.4050.201.224	931.4050.202.224	40 x 50 x 20	2 Sayaç + 24 Sigorta	6



930.2635.151.003



931.4050.202.224

Trifaze Sayaçlı

IP65

HALOJEN FREE

Ürün Kodu		Ölçü(cm)	Açıklama	📦
Opak Kapak	Şeffaf Kapak			
935.3040.131.010	935.3040.132.010	30 x 40 x 13	1 Sayaç + 10 Sigorta	10
935.3040.171.010	935.3040.172.010	30 x 40 x 17	1 Sayaç + 10 Sigorta	8
935.4050.201.008	935.4050.202.008	40 x 50 x 20	1 Sayaç + 8 Sigorta	6
935.4060.201.008	935.4060.202.008	40 x 60 x 20	1 Sayaç + 8 Sigorta	6
935.5070.251.010	935.5070.252.010	50 x 70 x 25	1 Sayaç + 10 Sigorta	4
942.5070.251.000	942.5070.252.000	50 x 70 x 25	Kompakt Şalter + Kaçak Akım + Akım Trafo	4



936.4050.202.008



935.4060.201.008



935.5070.252.010



942.5070.251.000

Trifaze Sayaç + Dağıtım

IP65

HALOJEN FREE

Ürün Kodu		Ölçü(cm)	Açıklama	📦
Opak Kapak	Şeffaf Kapak			
936.4050.201.024	936.4050.202.024	40 x 50 x 20	1 Sayaç + 24 Sigorta	6
936.4060.201.040	936.4060.202.040	40 x 60 x 20	1 Sayaç + 40 Sigorta	6
936.5070.251.068	936.5070.252.068	50 x 70 x 25	1 Sayaç + 68 Sigorta	4



936.4050.202.024



936.4060.201.040



936.4050.252.068

Şantiye Panoları

IP65

HALOJEN FREE

Ürün Kodu		Ölçü(cm)	Açıklama	
Opak Kapak	Şeffaf Kapak			
965.4060.201.024	965.4060.202.024	40 x 60 x 20	1 Trifaze Sayaç + 24 Sigorta + 3 Priz Yeri	6
965.5070.251.048	965.5070.252.048	50 x 70 x 25	1 Trifaze Sayaç + 48 Sigorta + 4 Priz Yeri	4
965.5070.251.028	965.5070.252.028	50 x 70 x 25	1 Trifaze Sayaç + 28 Sigorta + 8 Priz Yeri	4
966.4050.201.032	966.4050.202.032	40 x 50 x 20	32 Sigorta + 3 Priz Yeri	6
966.4060.201.048	966.4060.202.048	40 x 60 x 20	48 Sigorta + 3 Priz Yeri	6
966.4060.201.032	966.4060.202.032	40 x 60 x 20	32 Sigorta + 6 Priz Yeri	6
966.5070.251.060	966.5070.252.060	50 x 70 x 25	60 Sigorta + 8 Priz Yeri	4



966.4050.202.032



966.4060.201.032



965.4060.202.024



965.5070.251.028

Kofra Panoları

IP65

HALOJEN FREE

Ürün Kodu		Ölçü(cm)	
Opak Kapak	Şeffaf Kapak		
923.2635.151.000	923.2635.152.000	26 x 35 x 15	12
923.3040.171.000	923.3040.172.000	30 x 40 x 17	8
923.4050.201.000	923.4050.202.000	40 x 50 x 20	6



923.2635.151.000



923.3040.171.000



923.4050.202.000

**Harici Telefon Dağıtım
Opak Kapaklı**

IP65

HALOJEN FREE

Ürün Kodu	Ölçü(cm)	Açıklama	
XXX.2130.131.030	21 x 30 x 13	Çatı + Regletli 30 Per	20
XXX.2635.151.050	26 x 35 x 15	Çatı + Regletli 50 Per	12
XXX.3040.131.100	30 x 40 x 13	Çatı + Regletli 100 Per	10
XXX.3040.171.100	30 x 40 x 17	Çatı + Regletli 100 Per	8
XXX.4050.201.150	40 x 50 x 20	Çatı + Regletli 150 Per	6
XXX.4050.201.200	40 x 50 x 20	Çatı + Regletli 200 Per	6
XXX.4050.201.300	40 x 50 x 20	Çatı + Regletli 300 Per	6
XXX.4060.201.400	40 x 60 x 20	Çatı + Regletli 400 Per	6
XXX.5070.251.500	50 x 70 x 25	Çatı + Regletli 500 Per	4
XXX (950) Boş	XXX (951) Çatılı	XXX (952) Çatılı + Regletli	

**Harici Telefon Dağıtım
Şeffaf Kapaklı**

IP65

HALOJEN FREE

Ürün Kodu	Ölçü(cm)	Açıklama	
XXX.2130.132.030	21 x 30 x 13	Çatı + Regletli 30 Per	20
XXX.2635.152.050	26 x 35 x 15	Çatı + Regletli 50 Per	12
XXX.3040.132.100	30 x 40 x 13	Çatı + Regletli 100 Per	10
XXX.3040.172.100	30 x 40 x 17	Çatı + Regletli 100 Per	8
XXX.4050.202.150	40 x 50 x 20	Çatı + Regletli 150 Per	6
XXX.4050.202.200	40 x 50 x 20	Çatı + Regletli 200 Per	6
XXX.4050.202.300	40 x 50 x 20	Çatı + Regletli 300 Per	6
XXX.4060.202.400	40 x 60 x 20	Çatı + Regletli 400 Per	6
XXX.5070.252.500	50 x 70 x 25	Çatı + Regletli 500 Per	4
XXX (950) Boş	XXX (951) Çatılı	XXX (952) Çatılı + Regletli	



952.2635.152.050



952.3040.131.100



952.4050.202.200



952.5070.251.500

Sulama Panoları

IP65

HALOJEN FREE

Ürün Kodu		Ölçü(cm)	Açıklama	
Opak Kapak	Şeffaf Kapak			
960.4050.201.000	960.4050.202.000	40 x 50 x 20	Voltmetre + Ampermetre + Sinyal	6
960.4060.201.000	960.4060.202.000	40x 60 x 20	Voltmetre + Ampermetre + Sinyal	6
960.5070.251.000	960.5070.252.000	50 x 70 x 25	Voltmetre + Ampermetre + Sinyal	4



960.4050.202.000



960.4060.201.000



960.5070.252.000

Pano Aksesuarları

Ürün Kodu	Açıklama	
740.020.000	(40 x 50 - 40 x 60 - 50 x 70) Pano Ayak	1
740.030.026	26 x 35 Pano Çatı	1
740.030.030	30 x 40 Pano Çatı	1
740.030.045	(40 x 50 - 40 x 60) Pano Çatı	1
740.030.050	50 x 70 Pano Çatı	1
740.010.001	Reglet - Kesmeli	100
740.011.000	Çatı - Tekli	100



740.011.000



740.010.001

**M150 Plastik Gövdeli
Kablosuz Makaralar**

Ürün Kodu

Açıklama



150.000.04

4(1x16A) Şebeke

10



150.000.04.T

4(1x16A) Şebeke + Termikli

10

**M100 Metal Gövdeli Kablosuz
Makaralar - Sinyal Ledli**

Ürün Kodu

Açıklama



100.000.004

4(1x16A) Şebeke

10



100.000.004.T

4(1x16A) Şebeke + Termikli

10

Makara Cinsi	Kablo Kesiti	3x1,5 TTR	3x2,5 TTR	3x4 TTR	4x1,5 TTR	4x2,5 TTR	4x4 TTR	5x1,5 TTR	5x2,5 TTR	5x4 TTR
M100		50	40	30	-	-	-	-	-	-
M120		100	75	60	80	65	45	75	50	40
M150		60	50	40	-	-	-	-	-	-

M120 Kablosuz Makaralar

M120 Metal Gövdeli

Ürün Kodu	12X.000.004	12X.000.004.T	12X.000.004E	12X.316.012	12X.416.012
Makara Göbekleri					
Açıklama	4(1x16A) Şebeke + Sinyal	4(1x16A) Şebeke + Sinyal + Termikli	4(1x16A) Pano Prizi + Sinyal	1(3x16A) CEE + 2(1x16A) Pano Prizi	1(4x16A) CEE + 2(1x16A) Pano Prizi

Ürün Kodu	12X.516.012	12X.425.012	12X.332.012	12X.432.012	12X.532.012
Makara Göbekleri					
Açıklama	1(5x16A) CEE + 2(1x16A) Pano Prizi	1(4x25A) CEE + 2(1x16A) Pano Prizi	1(3x32A) CEE + 2(1x16A) Pano Prizi	1(4x32A) CEE + 2(1x16A) Pano Prizi	1(5x32A) CEE + 2(1x16A) Pano Prizi

X = 0 Borulu Makara X = 1 Arabalı Makara X = 2 Tekerlekli Makara

Makara Cinsi	Kablo Kesiti	3x1,5 TTR	3x2,5 TTR	3x4 TTR	4x1,5 TTR	4x2,5 TTR	4x4 TTR	5x1,5 TTR	5x2,5 TTR	5x4 TTR
M120		100	75	60	80	65	45	75	50	40



120.000.004.T





122.416.012



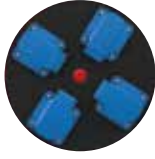

121.425.012

M130 Kablosuz Makaralar

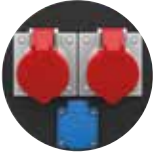
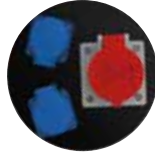
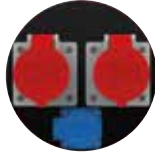
M130 Metal Gövdeli

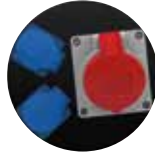
Ürün Kodu	13X.000.004	13X.416.012	13X.416.021	13X.516.012	13X.516.021
Makara Göbekleri					
Açıklama	4(1x16A) Pano Prizi + Sinyal	1(4x16A) CEE + 2(1x16A) Pano Prizi	2(4x16A) CEE + 1(1x16A) Pano Prizi	1(5x16A) CEE + 2(1x16A) Pano Prizi	2(5x16A) CEE + 1(1x16A) Pano Prizi

Ürün Kodu	13X.425.012	13X.425.021	13X.332.012	13X.432.012	13X.532.012
Makara Göbekleri					
Açıklama	1(4x25A) CEE + 2(1x16A) Pano Prizi	2(4x25A) CEE + 1(1x16A) Pano Prizi	1(3x32A) CEE + 2(1x16A) Pano Prizi	1(4x32A) CEE + 2(1x16A) Pano Prizi	1(5x32A) CEE + 2(1x16A) Pano Prizi

X = 0 Borulu Makara X = 1 Arabalı Makara X = 2 Tekerlekli Makara

Makara Cinsi	Kablo Kesiti	3x1,5 TTR	3x2,5 TTR	3x4 TTR	4x1,5 TTR	4x2,5 TTR	4x4 TTR	5x1,5 TTR	5x2,5 TTR	5x4 TTR
M130		120	100	75	100	80	55	100	70	50



130.516.012



132.532.012



131.516.021

M140 Kablosuz Makaralar

M140 Metal Gövdeli

Ürün Kodu

14X.416.022

14X.516.022

14X.425.022

14X.432.022

14X.532.022

Makara Göbekleri

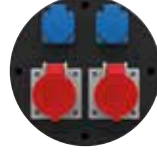

Açıklama

2(4x16A) CEE +
2(1x16A) Pano Prizi

2(5x16A) CEE +
2(1x16A) Pano Prizi

2(4x25A) CEE +
2(1x16A) Pano Prizi

2(4x32A) CEE +
2(1x16A) Pano Prizi

2(5x32A) CEE +
2(1x16A) Pano Prizi

X = 0 Borulu Makara X = 1 Arabalı Makara X = 2 Tekerlekli Makara

Makara Cinsi	Kablo Kesiti	3x1,5 TTR	3x2,5 TTR	3x4 TTR	4x1,5 TTR	4x2,5 TTR	4x4 TTR	5x1,5 TTR	5x2,5 TTR	5x4 TTR
M100		50	40	30	-	-	-	-	-	-
M120		100	75	60	80	65	45	75	50	40
M130		120	100	75	100	80	55	100	70	50
M140		180	140	125	170	130	100	135	110	90
M150		60	50	40	-	-	-	-	-	-
M160		60	50	40	50	35	25	-	-	-



140.432.022



142.516.022



141.532.022



TEM

Acil Aydınlatma

Sabit ve seyyar olarak kullanılabilen ürünümüz, elektrik kesintisinde otomatik devreye girer ve fabrikalar, otoparklar, uzun koridorlar gibi geniş kullanım alanına sahiptir.



200.127.000

Çift Spotlu Acil Aydınlatma



200.127.100

Çift Spotlu Acil Aydınlatma
+ Şarj Göstergesi









100.023.000

Tek Spotlu Acil Aydınlatma

	Çalışma Voltajı	Lamba	Renk Sıcaklığı	Şarj Süresi (Saat)	Çalışma Sıcaklığı	Koruma Sınıfı	Elektrik Sınıfı	Batarya Kapasitesi	Çalışma Süresi(dk)	Ürün Boyutları
Çift Spotlu Acil Aydınlatma	220-230V AC / 50-60Hz	2x9 Led	6000 - 6500 K	24	-10°C.... +40° C	IP 40	II	12V 2.3Ah Lead Acid Battery	180	355x135x400
Tek Spotlu Acil Aydınlatma	220-230V AC / 50-60Hz	2x9 Led	6000 - 6500 K	24	-10°C.... +40° C	IP 40	II	3,6V 1800mAh NiCd Battery	120	135x100x365

Acil aydınlatma modelleri için fiyat sorunuz.

1 KV Bara Mesnet İzolatörleri

Fiçi Tip 1 KV	Ürün Kodu	Açıklama	
 722.120.005	722.120.005	M5 Kör Somunlu Fiçi Tip	250
	722.120.008	M8 Kör Somunlu Fiçi Tip	50
	722.120.010	M10 Kör Somunlu Fiçi Tip	50
 722.102.005	722.102.005	M5 Cıvatalı Fiçi Tip	250
	722.102.008	M8 Cıvatalı Fiçi Tip	50
	722.102.010	M10 Cıvatalı Fiçi Tip	50
 722.111.005	722.111.005	M5 Cıvata + Kör Somunlu Fiçi Tip	250
	722.111.008	M8 Cıvata + Kör Somunlu Fiçi Tip	50
	722.111.010	M10 Cıvata + Kör Somunlu Fiçi Tip	50
 722.220.006	722.220.006	M6 Kör Somunlu Konik Tip	100
	722.220.008	M8 Kör Somunlu Konik Tip	50
	722.220.010	M10 Kör Somunlu Konik Tip	50
 722.202.006	722.202.006	M6 Cıvatalı Konik Tip	100
	722.202.008	M8 Cıvatalı Konik Tip	50
	722.202.010	M10 Cıvatalı Konik Tip	50
 722.211.006	722.211.006	M6 Cıvata + Kör Somunlu Konik Tip	100
	722.211.008	M8 Cıvata + Kör Somunlu Konik Tip	50
	722.211.010	M10 Cıvata + Kör Somunlu Konik Tip	50

Tarak İzolatörler

Ürün Kodu	Açıklama	
722.331.000	Tek Bara Taraklı - Üç Fazlı	24
722.332.000	Çift Bara Taraklı - Üç Fazlı	24
722.333.000	Üç Bara Taraklı - Üç Fazlı	24
722.341.000	Tek Bara Taraklı - Üç Fazlı + Nötr	24
722.342.000	Tek Bara Taraklı - Üç Fazlı + Nötr	24

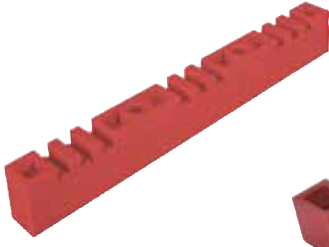

722.333.000

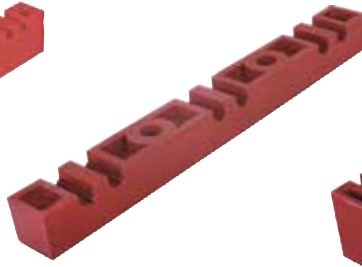

722.332.000

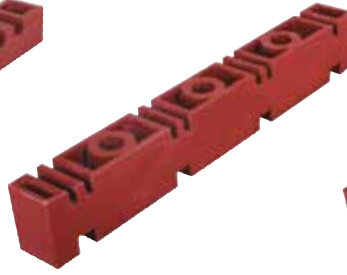

722.342.000



722.331.000

1N Serisi İzolatörler

Ürün Kodu	Açıklama	
722.100.001	1N -B M16 Kör Somunlu	12
722.100.002	1N -C M16 Kör Somunlu	12
722.100.003	1N -D M16 Kör Somunlu	12
722.100.004	1N -K M16 Kör Somunlu	12
722.100.005	1N - 500 M16 Kör Somunlu	12
722.100.008	Bara Tutucu Serfil	12



722.100.003



722.100.004



722.100.005



722.100.001





722.100.002



722.100.008

Seyyar Lamba - Baladoz

Anahtarlı	Ürün Kodu	Açıklama
	785.000.010	Kablosuz
	785.105.010	5m. Kablolu
	785.110.010	10m. Kablolu
	785.115.010	15m. Kablolu
	785.120.010	20m. Kablolu
	785.125.010	25m. Kablolu

Anahtarsız	Ürün Kodu	Açıklama
	785.000.020	Kablosuz
	785.105.020	5m. Kablolu
	785.110.020	10m. Kablolu
	785.115.020	15m. Kablolu
	785.120.020	20m. Kablolu
	785.125.020	25m. Kablolu

Seyyar Lamba - Çanaklı Baladoz

Anahtarlı	Ürün Kodu	Açıklama
	786.000.010	Kablosuz
	786.107.010	7.5m. Kablolu

Anahtarsız	Ürün Kodu	Açıklama
	786.000.020	Kablosuz
	786.107.020	7.5m. Kablolu

Bant Armatür Soketleri787.100.100
Tekli Klasik787.100.200
Çiftli Klasik787.300.000
Starter Yuvası**Fiyat Sorunuz.**

24V 100W

Kablolar725.315.113
Çift Topraklı Fişli Kablo
3G 1,5 H0VV-F 3m.725.325.113
Çift Topraklı Fişli Kablo
3G 2,5 H0VV-F 3m.725.310.212
Güç Kablosu
3G 1 H0VV-F 1,8m.725.315.123
İngiliz Fişli Kablo
3G 1,5 H0VV-F 3m.**Kablolar için fiyat sorunuz.****Kablo Bağı****Ürün Kodu****Açıklama**

736.230.210	2.5 x 100	100
736.230.214	2.5 x 140	100
736.230.220	2.5 x 200	100
736.230.315	3.6 x 150	100
736.230.320	3.6 x 205	100
736.230.325	3.6 x 250	100
736.230.330	3.6 x 300	100
736.230.337	3.6 x 370	100
736.230.420	4.8 x 200	100
736.230.425	4.8 x 250	100
736.230.430	4.8 x 300	100
736.230.435	4.8 x 350	100
736.230.440	4.8 x 400	100
736.230.845	8 x 450	100
722.230.855	8 x 550	100
722.230.976	9 x 762	100
722.230.994	9 x 940	100





TEM®

TEM TEKNİK ELEKTRİK MALZEMELERİ SANAYİ VE TİCARET ANONİM ŞİRKETİ

 Selimpaşa Ortaköy Sanayi Bölgesi, İlter Bulvarı, Mor Menekşe Sok, No:5 34590
SİLİVRİ / İSTANBUL / TÜRKİYE

 +90 212 485 19 00

 +90 212 485 15 33

 www.temteknik.com

 info@temteknik.com